

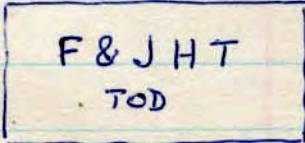
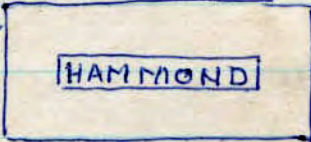

Fire Bricks

1. Plain fire brick stamped
T. TEMPERLEY. 
- with dark coloured centre, presumably result of
manner in which they were stacked in kiln
slightly tapered
2. Plain fire brick - stamped
F + J. H. TEMPERLEY. TAD. 
- (closed down 1975)
3. Fire brick - single narrow frog
GLEN B + T. CO.
4. HAMMOND. plain ^{reverse} 
5. REVO - electric storage heater brick.
 plain reverse.
6. Stonyhurst College - lining of chimney
demolished 1945.
7. Plain fire brick DOUGLAS D.
no frog (Douglas Fire Brk Co. Dalry)
8 1/2 lbs 9" x 4 1/2" x 3" ^{Ayrshire} 
8. Plain fire brick THISTLE.
no frog (G. R. Stein Refractories Ltd.) 
9. Plain fire brick 9" x 4 1/4" x 2 7/8"
no frog. Stamped 1 side only
MOBBERLEY PERRY LTD 7 1/2 lbs. 
- STOURBRIDGE stamp off centre
10. Plain fire brick.
no frog. Stamped 1 side only
GLENBOIG. (Gastosh)
(G. R. Stein Refractories Ltd) 1889 - 

Glenboig Star fine clay wks. Glenboig, Lanarkshire 1836 - 1950/1960.

STAR WORKS GLENBOIG (Gastoshy).

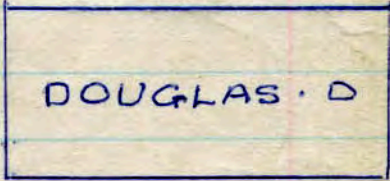
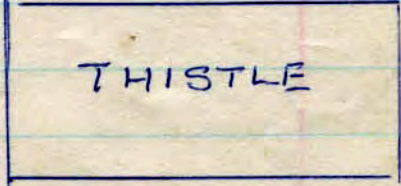
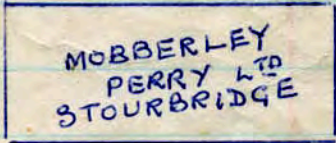
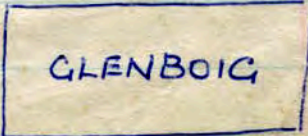
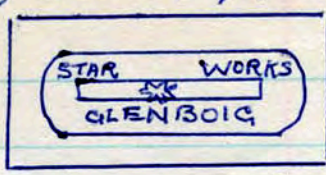

✓ 162 x
obverse - single frog, rounded ends
reverse - plain. (1 pointed star impress in bar - obverse)
frog 6 1/2" x 1 3/4". bar. 5" x 3/4" 9 lbs. 9" x 4 1/4" x 3"

DOUGALL A. plain fine brick 9" x 4 1/2" x 3"

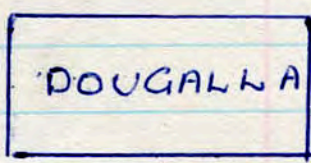

✓ 190 x
no frog. stamped 1 side only. 8 1/2 lbs
(Alie Dougal & Sons Ltd. Winchburg, West Lothian) (1873 - 1970)

✓ Special fine brick.

✓ 249 x
7 lbs.

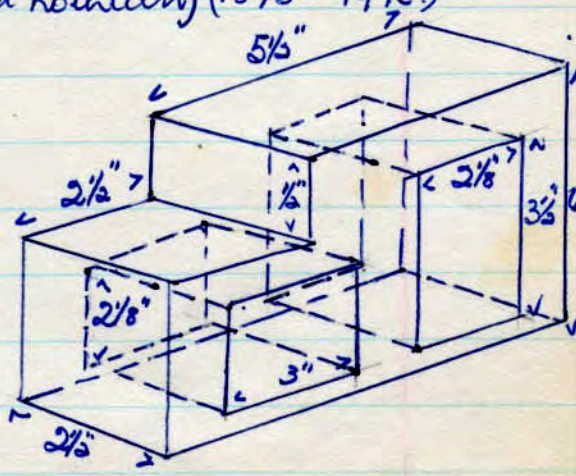

✓ GLENBOIG T 16 (crown). Glenboig Star Wks. - as 162 above.

✓ 263 x
flue arch fine brick. 7 1/2 lbs. 9" x 4 3/8" x 3" - 2"
3" taper to 2"

✓ G. HEAT ON SHIPLEY

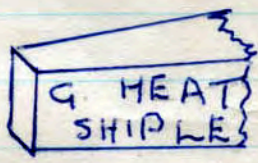

flue arch fine brick.

Plain brick, no name, no frog.

✓ 296 x
2 serrated faces

Plain fine brick 9 1/4" x 4 1/2" x 3"



✓ 319 x
stamped 1 side NETTLE 9 lbs.

(G.R. Stein Refractories Ltd) late 19th

✓ 320 x
C slightly cambered kiln brick

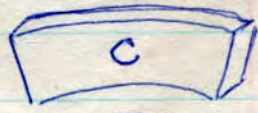

✓ 321 x
50 R special fine kiln brick.



✓ 343 x
REK fine brick - no panel



(R.E. Knowles - Furness Vale. 9" x 4 1/2" x 3"

✓ 344 x
CINDRINS - fine brick - single panel obverse

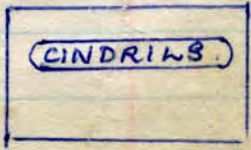

(Morton's. Elland. Yorks) 8 lbs. 9" x 4 1/2" x 2 3/4"

✓ GREENGATE FIREPROOF ST HELENS
x 415 ✓ single panel each side 8 7/8" x 4" x 3"
8 lbs.

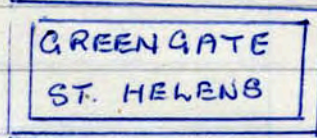
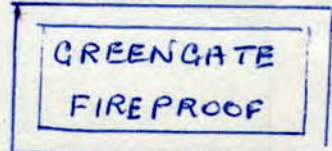

✓ H R BOWERS RUABON. 8 7/8" x 4 1/4" x 3 3/16"
x 416 ✓ single deep panel obverse only. (1 1/2")



8 lbs.

✓ GLENBOIG W 8 (Gartosh) 8 lbs
x 471 ✓ flue arch fire brick. 9" x 4 1/2" x 3"
(G.R. Stein Refractories Ltd). 1836-1950/1960.

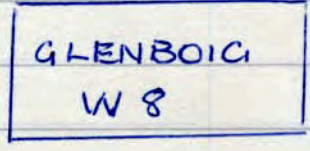

x ✓ G C R (G. Clarke, Rishton)
x 485 ✓ plain fire brick

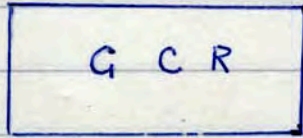

✓ L P D
x 486 ✓ plain fire brick



✓ RUFFORD STOURBRIDGE
x 488 ✓ fire brick, single panel, one side.
R O F 7 lbs. 4 1/2" x 3"

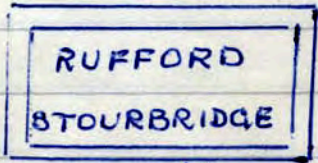

x 499 ✓ cambered fire brick

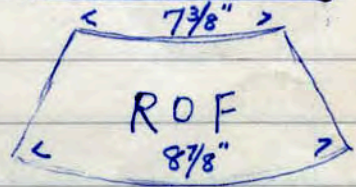

x 532 ✓ PLUMB. 9" x 4 1/2" x 2"
x ✓ fine brick.

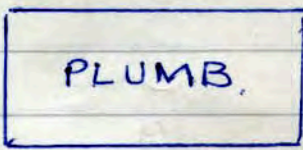

✓ HALL O B STOURBRIDGE. 9 lbs.
x 534 ✓ plain fire brick 8 7/8" x 4 1/2" x 3"
name stamped one side.

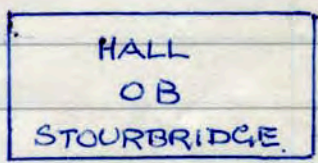

x 568 ✓ T B. fire clay 9" x 4 1/2" x 2 5/8"
x ✓ single panel each side 7 lbs.

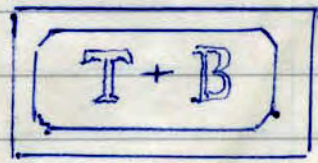

x 577 ✓ BLACKSTONE EDGE. 9" x 4 1/2" x 3"
x ✓ fine brick, stamped one face.
(Rochdale - 8 1/2 lbs.)

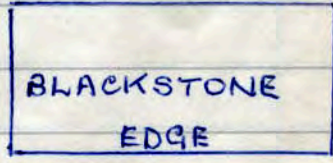

x 578 ✓ J. LOMAX KIT BOOTH. 9" x 4 1/2" x 2 7/8"
x ✓ fine brick, stamped one face.
(the Marston).

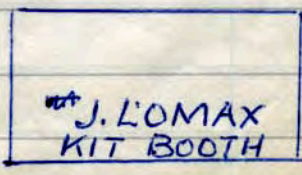

576.
x

F C° fire clay brick
single deep panel each side

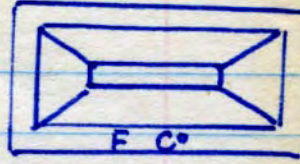

1140
x

UFP (United Fireclay Products)
letters incised, single panel each side
S. Spencer

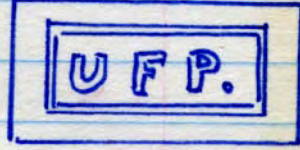

No name. fire clay kiln grate
28 lbs. 12" x 12" x 3 3/4"

9 perfs 1 7/8" diam on 1 side to 2 1/4" diam on rev.
no panels. salt glazed.

Duckett's dem. Blannel St. Burnley. 15. 2. 81

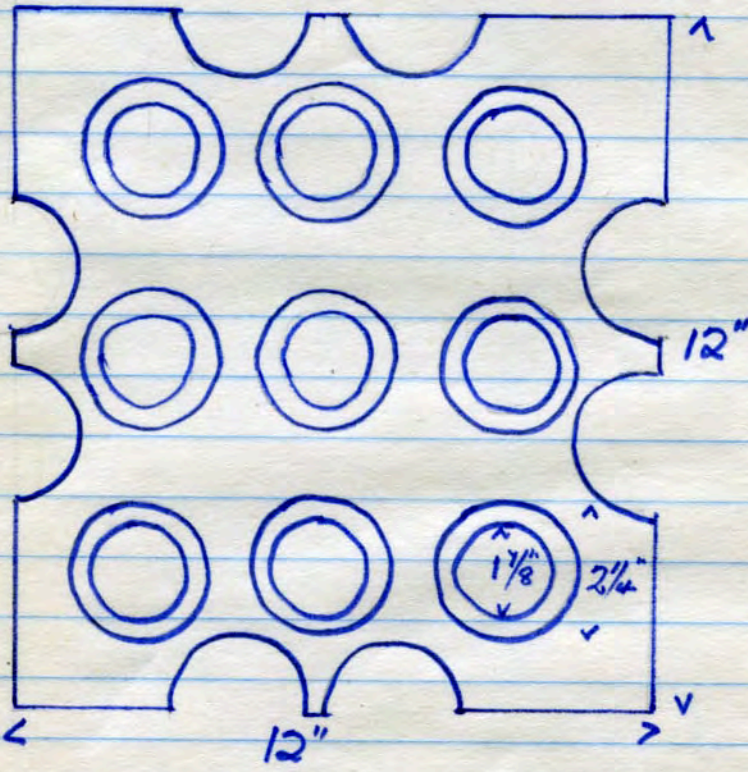

116
x

no used from
repeat RIKHURST

H G A .

plain fire brick, no panels
letters incised

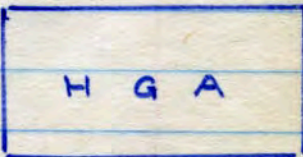

1176
x

no used
from repeat

8 lbs. 8 7/8" x 4 1/4" x 2 7/8"

Duckett's dem. Blannel St. Burnley. 15. 2. 81

F. I. CO LD 9" x 4 1/2" x 3"

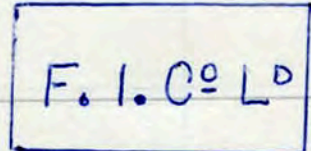

579 (b. Aspin - Bank at Helmsshore) stamped one face.



580 (D) stamped one face. 9" x 4 1/4" x 3" ex Gas Works, bloughfold. 8 lbs.

JOSEPH MORTON CINDER HILLS

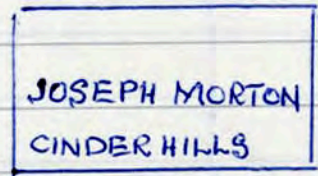

581 stamped one face

ex Gas Works. bloughfold.

FARNLEY IRON CO LEEDS

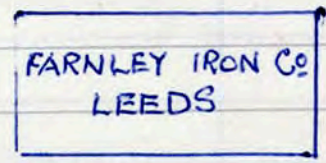

582 stamped one face.

ex Gas Works - bloughfold.

E. H. & CO ROSSENDALE

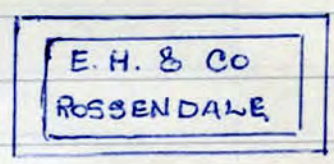

single panel both sides 8 lbs.

1603 deep panel obverse. 8 3/4" x 4 3/8" x 2 3/4"

plain " reverse.

(Roughline demolition site)

CLIFF (Mr Shutt - Leeds) 8 1/2 lbs.



1645 single panel each side 9" x 4 1/2" x 3 1/4"

(deeply incised large Roman letters)

TOMLINSON (Mr Shutt - Hull)

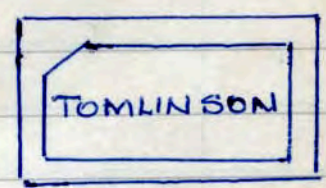

1646 single panel each side

(letters incised)

GLENBOIG G (Mr Spencer, Constablelee)

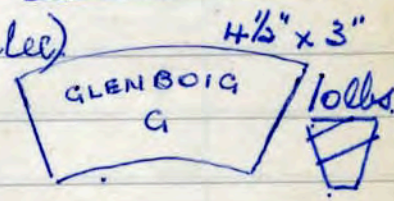

radial fine brick. Glenboig Star Tuesday Wks
Glenboig, Lanark.

1647 no panels. (letters incised) 1836 - 1950

GLENBOIG 2

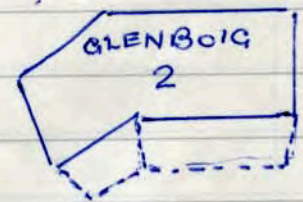

1648 squint reveal fine brick

no panels. (letters incised)

GLENBOIG 4

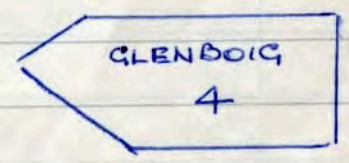

1649 squint fine brick

no panels (letters incised)

SANKEY ALUMA.

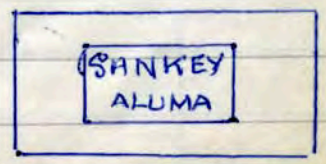

1674 stamped one side (letters incised)

ex bloughfold Gas Works

675
x
monogram in circle (H) or (M)
inscribed, one side.



ex bloughfold Gas Works.

NETTLE A ^{(Strain) late 19th} ggraded fire brick
letters incised in small panel.
DIBDALE GIBBONS (DUDLEY) LTD

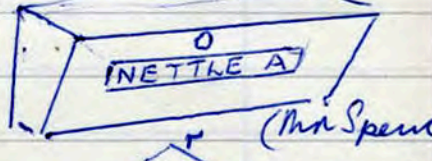

1698
x
triangular fire brick
(letters incised) (Mr Spencer) 4 1/2 lbs
DIBDALE GIBBONS (DUDLEY) LTD

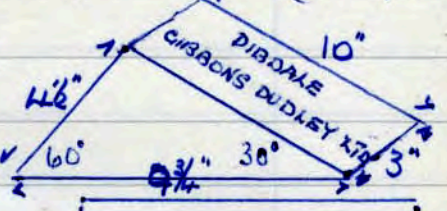

1699
x
fire brick. (letters incised) 8 lbs.
(Mr Spencer) 9 1/4" x 4 1/2" x 3"

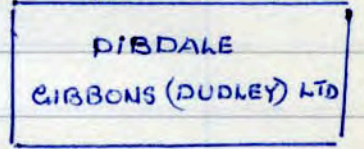

C. K HARRISON STOURBRIDGE
(9" x 4 1/4" x 3")
single stamped panel, one side only.

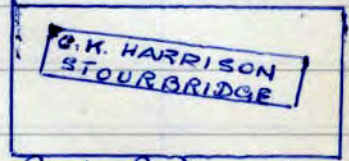

1703
x
fine brick. (letters incised) (Edgside - Park Rd) 8 lbs.

BROOKS & PICKUP TOWNELEY COLLIERY BURNLEY

1704
x
fine brick. (letters incised) 9" x 4 1/2" x 3"
partial glaze?, one edge. (Mr Spencer) 9 lbs.

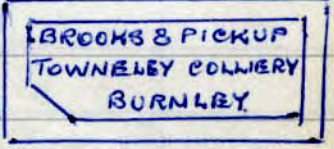

1736
x
P & S H X. B F (Overden)
fine brick, 9" x 4 1/2" x 2".
no panel, letters incised.

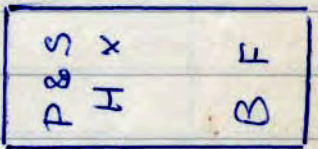

1766
x
SNEYD COLLIERY BURSLEM NR AA
fine brick, letters incised. (Shaw)

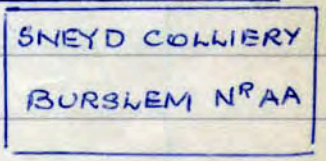

1777
x
HARRIS & PEARSON. STOURBRIDGE
slightly cambered kiln brick 3" x 3"
(Bury - David Hall & Sons, loom manuf'rs).
(letters incised)

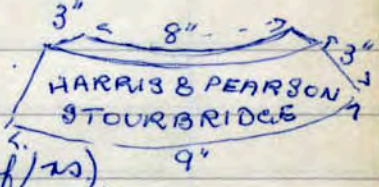

1778
x
RAVENS LODGE DEWSBURY 26 lbs.
REGISTERED TRADE MARK, tapered
segment from crucible 5 3/4" x 8 3/8" x 5 3/8" x 9"



1789
x
E. WILLIAMS - obverse BRADFORD MANCHESTER - reverse
single panel each side
(letters incised) (Gimcroft Lane)
8 7/8" x 4 1/8" x 3" Edenfield 8 lbs.

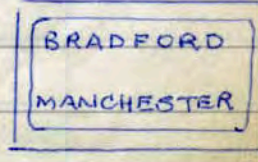
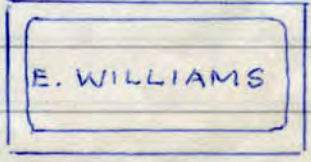

✓ 842 X	LION fire brick 9" x 4 1/2" x 2 1/2" letters incised, no panel. Stein	<div style="border: 1px solid black; padding: 5px; text-align: center;">LION</div>
✓ 843 X	Special brick made by Stein of Bonnybridge, Glasgow no name, no panel. For refractory purposes only cream in colour (14 lbs weight) 9" x 4 1/2" x 3"	
✓ 847 X X	OBSIDIANITE 3 - 2 3/4 (letters incised) tapered - gauged arch fire brick small single panel one side only (G.R. Stein Refractories) 10 lbs 9" x 4 1/2" x 3" - 2 3/4"	<div style="border: 1px solid black; padding: 5px;"> <div style="border: 1px solid black; text-align: center; margin-bottom: 5px;">OBSIDIANITE</div> 3 - 2 3/4 </div>
✓ 848 X	no name - stamped 2 1/2 8 3/4" x 4 3/8" x 3" - 2 1/2" gauged bricks - no panel. (Stein) 9 lbs.	<div style="border: 1px solid black; padding: 5px; text-align: center;">2 1/2</div>
✓ 849 X	ADAMANTINE 3 - 2 (G.R. Stein Refractories) 8 3/4" x 4 1/4" x 3" - 2" gauged fire bricks - tapered, Stein. 7 lbs. letters incised in small panel, one side	<div style="border: 1px solid black; padding: 5px;"> <div style="border: 1px solid black; text-align: center; margin-bottom: 5px;">ADAMANTINE</div> 3 - 2 </div>
✓ 850 X	H A G fire brick 9" x 4 1/2" x 3" letters incised - one side only Stein	<div style="border: 1px solid black; padding: 5px; text-align: center;"> H A G </div>
✓ 851 X	N 23 B fire brick, cream colour letters incised - one side only Stein	<div style="border: 1px solid black; padding: 5px; text-align: center;">N23B</div>
✓ 852 X	L D P plain fire brick - grey colour tapered. 3" - 2 1/2" letters incised - one side.	<div style="border: 1px solid black; padding: 5px; text-align: center;">  </div>
✓ 853 X	E J & J PEARSON LTD STOURBRIDGE B. plain fire brick 9" x 4 1/2" x 2 1/2" letters incised - no panel.	<div style="border: 1px solid black; padding: 5px;"> EJ&J PEARSON LTD STOURBRIDGE B </div>
✓ 854 X	HYS 123 - 65 9" x 5 3/4" x 2 1/2" plain fire brick - letters incised 7 lbs.	<div style="border: 1px solid black; padding: 5px; text-align: center;"> HYS 123 - 65 </div>
✓ 855 X	F W B gauged fire brick 3" - 2 1/2" letters incised - no panel.	<div style="border: 1px solid black; padding: 5px; text-align: center;">F W B</div>
✓ 873 X	FOSTER R & MOORE LTD STOURBRIDGE 12" x 6" x 2" fire brick, no panel, (letters incised) FOSTER CROWN no panel, (incised letters)	<div style="border: 1px solid black; padding: 5px;"> R & MOORE LTD STOURBRIDGE </div>
✓ 874 X X	tapered fire brick 6" - 5 1/2" x 3" x 9" (14 lbs) ALU 70 518 Z	<div style="border: 1px solid black; padding: 5px;"> FOSTER CROWN 6" 9" </div>
✓ 875 X	tapered fire brick 4" - 3 3/4" x 9 3/4" x 4" letters incised (27 lbs)	<div style="border: 1px solid black; padding: 5px; text-align: center;"> ALU 70 518 Z </div>

859
✓ x x

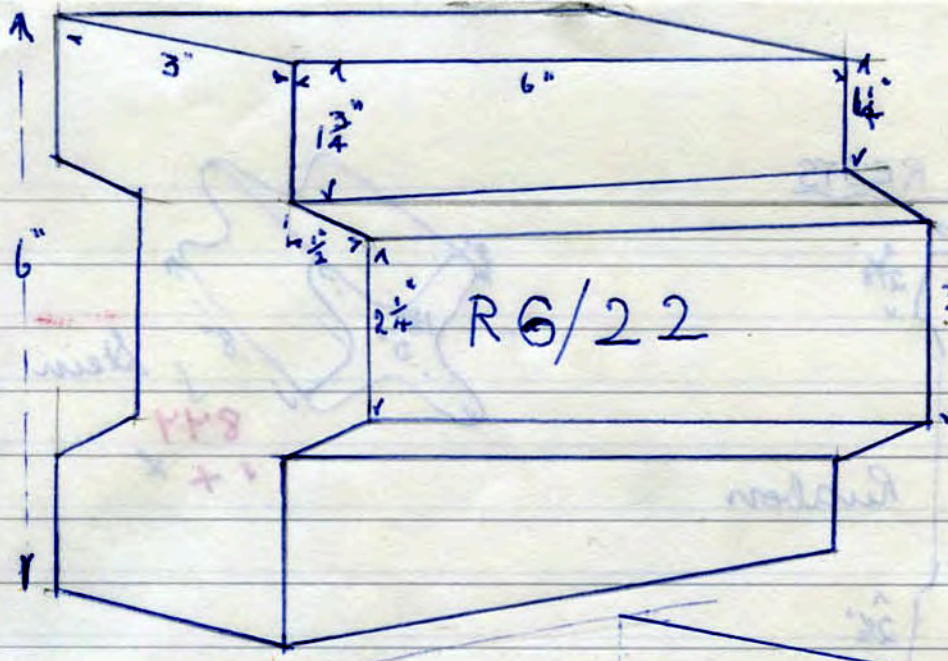

3 1/4" Exc Stein
(No Chester)
8 lbs

1861
✓ x x

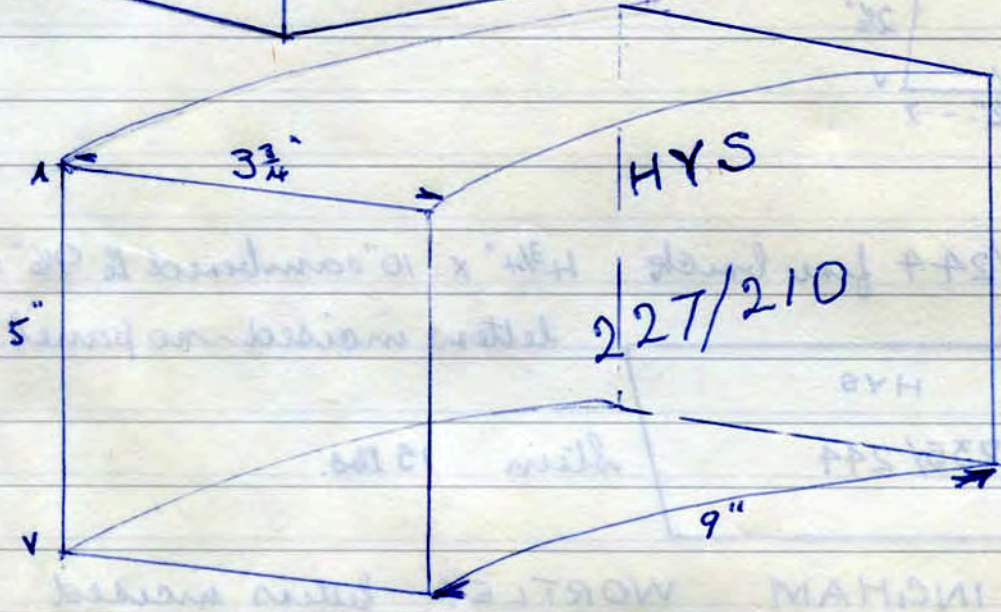

12 lbs

1858
✓ x x

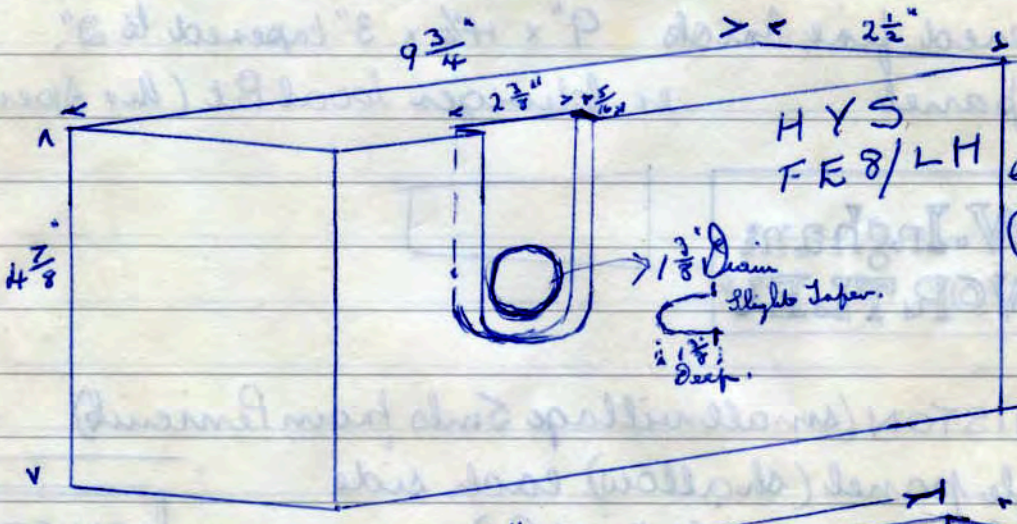

Exc Stein
(No Chester)
9 lbs.

1860
✓ x x

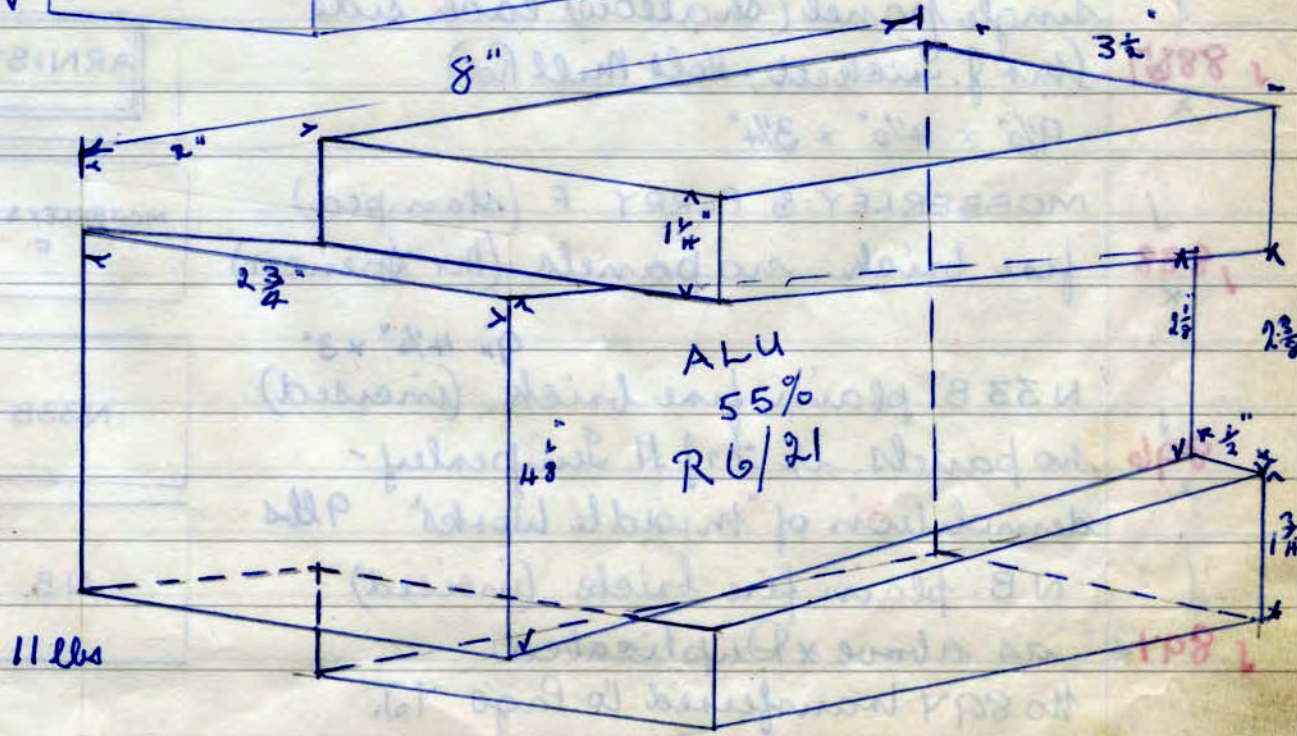

11 lbs

KILN RESTS

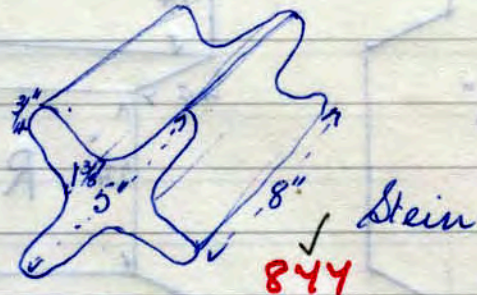
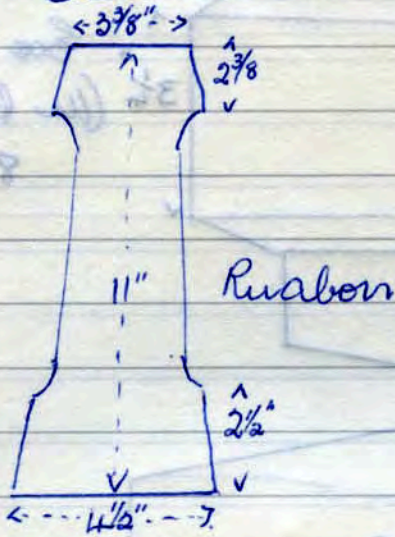

876
X

235/244 fire brick 4 3/4" x 10" chamfered to 9 1/2" x 3 3/4"
letters incised - no panel.

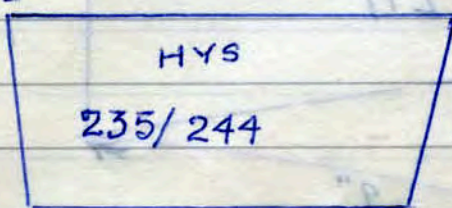

Stein 15 lbs.

881
X

W INGHAM WORTLEY letters incised
Tapered fire brick 9" x 4 1/2" x 3" tapered to 2".
no panel ex bliviger local Pit. (Mr Spencer)

882
X



ARNISTON (small village 5mls from Penicub)

single panel (shallow) each side
(Mr J. Tickett, Holt Mill Rd.)

9 1/2" x 4 1/2" x 3 1/4"

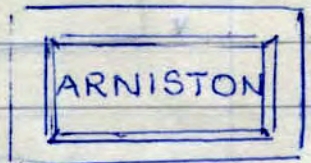

8867
X

MOBBERLEY & PERRY F (stamped)
fire brick. no panels. (Mr Spencer)

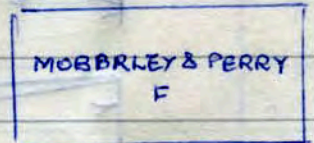

888
X

N33B plain fire bricks, (incised)
no panels. ex 7 of H Temperley -
demolition of "Middle Works" 9 lbs

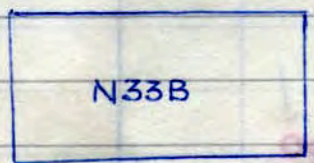

896
X

N.B. plain fire bricks, (incised)
as above x Duplicated.

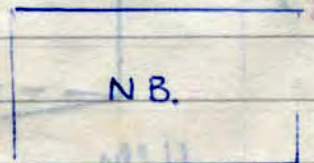

897
X

No 897 transferred to Page 7J.

✓
 905 ✓ x x
 DOUGLAS- x fine buck $9 \times 4\frac{1}{2} \times 2\frac{1}{2}$ "
 letters incised, one side only. 8 1/2 lbs
 (Douglas Line Bk Co, Dalry Ayrshire). 1914 - 1960.

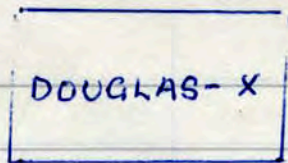

✓
 943 ✓ x x
 Half bull nose, no name, no panel
 fine brick - ex R. B. Seville's bakehouse.

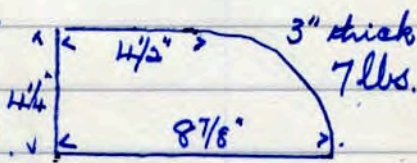

✓
 955 ✓ x
 WORTLEY (letters incised) fine brick.
 no panel. line incised, as letters
 (Mile St - R/dale - boiler house demolition).

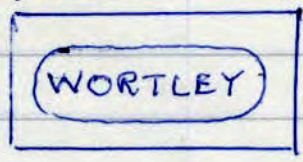

✓
 956 ✓ x
 HALL O B STOURBRIDGE fine brick
 quadrant nosed, no panels (letters incised)
 (spare ground - brawford Mill, R/dale).

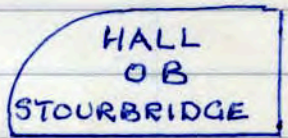

✓
 961 ✓ x x
 GLENBOIG YII
 letters stamped - incised
 gauged $3'' - 3\frac{3}{4}''$ Glenboig Star Linedlay Wks.
 fine brick, no panel Glenboig
 Enysly - Shones Bk Wks demolition. Kanark.
 reverse - plain. 1936 - 1950.



✓
 966 ✓ x
 EDWARD SMITH & CO COALVILLE.
 single panel, one side only.
 letters in relief.

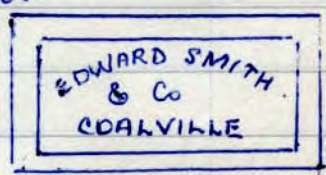

✓
 979 ✓ x
 GLENBOIG chamfered flue brick
 no panel, name stamped, one side
 (looppe - Bridge end to Laundry Vale).
 (G.R. Stein).

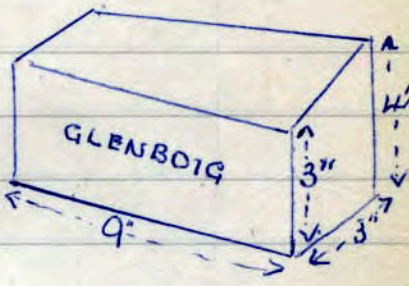

✓
 988 ✓ x
 CLIF & SONS LEEDS WORTLEY
 stamped. 7 lbs. $9 \times 4\frac{1}{2} \times 2\frac{1}{2}$ "
 fine brick (Gartcosh Steel, Motherwell)



✓
 1024 ✓ x
 GARTCOSH arch fine brick $3'' - 3\frac{1}{4}''$
 small panel, letters incised
 (Inwell Springs, Bacup)

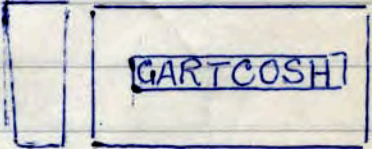

✓
 1025 ✓ x
 C D gauged brick $4\frac{1}{2}'' - 3\frac{3}{4}''$
 fire clay. no panel, letters incised.
 (Inwell Springs, Bacup)

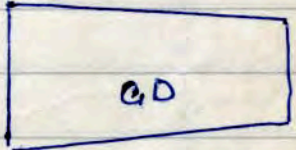

✓
 1026 ✓ x
 N B pure fire clay (white).
 no panel. letters incised
 (Inwell Springs, Bacup)
 (North Britain - Brodie)

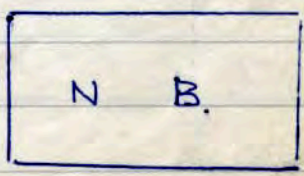

9" x 4 1/2" x 2 1/2"

1024 ✓
x

W F B pure white fine clay brick
small panel, one side only. 5" x 1 1/4" 7lbs.

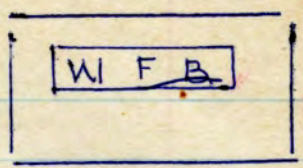

letters incised (Aspen bellery coke ovens, church)

MOBBERLEY & PERRY LTD STOURBRIDGE

1047 ✓
x

fine brick see R.U. GAS, 8 1/2" x 8 1/2" x 3"-2 1/2"
stamped letters, incised, no panel.
15lbs.

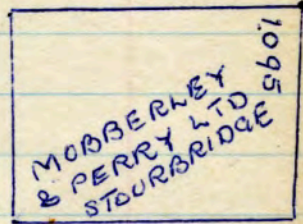

1064 ✓
x

CHIFF & SONS LEEDS WORTLEY
plain fine brick. no panels.
lettering stamped (Mr. Shutt).

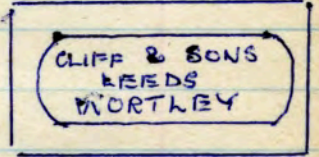

SHAWS BLACKBURN

1065 ✓
x

fine brick, panel each side. deep.
letters incised, one each side.

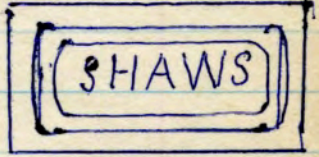

(x Enfield Brick - Deerplay Works.)

1096 ✓
x

THISTLE C plain fine brick 8lbs.
letters incised (G.R. Stein). 9" x 4 1/4" x 3"-2 3/4"

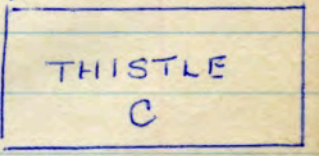

ROCK BRICK CO BUCKLEY FLINTSHIRE

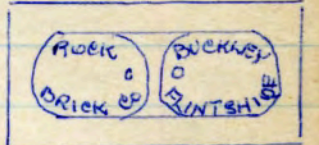

double panel obverse

1097 ✓
x

single " reverse (rectangular deep).
(Bacup Co-op) letters incised

THISTLE 99-108 (lining brick)

1122 ✓
x

no panels. letters incised
(Mr. Spencer - Bury Infirmary) (G.R. Stein)

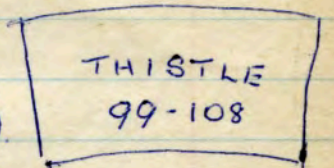

1133 ✓
x

K plain fine brick. no panels
large letter incised. 3 1/2" x 2 1/2"
(Mr. Spencer - Walshaw). 7lbs
(R.E. Knowles, Furness Vale).

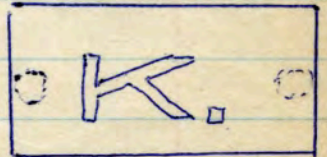

1134 ✓
x

POULTONS PATENT READING.
shaped fine bricks, name stamped on side
no panels. (Mr. Spencer

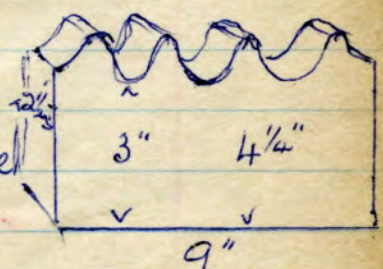

POULTON & SON 8 1/2 lbs

1141 ✓
x

plain fine brick, no panels. 9 1/8" x 4 1/2" x 2 3/4"
letters incised (Liverpool). (Reading)

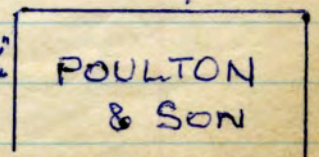

DOCKEN

48 - 57

~~DOCKEN~~ DOCKEN 48 - 57 no panel

1196 $\frac{1}{4}$ " sanded fine brick, gauged $7\frac{3}{4}$ " - $8\frac{3}{4}$ " x $4\frac{1}{2}$ " x $2\frac{3}{4}$ "
letters incised. (Mrs B. Steeple - London). (H. 9. '78)

SELCIO $7\frac{3}{4}$ " x $5\frac{1}{4}$ " x $2\frac{1}{2}$ "

SELCIO

1197 plain fine brick, letters incised
(Snydale Brk Wks - Featherstone, Yorks. 3. 9. '78)

I A SELCIO

I A SELCIO

1198 plain fine brick, letters incised
 13 " x $5\frac{1}{4}$ " x $2\frac{1}{2}$ " stamped on edge. (Snydale - 3. 9. '78)

L A

L A

1199 plain fine brick, letters incised
no panel 10 " x $5\frac{1}{4}$ " x $2\frac{1}{2}$ "
(Snydale, 3. 9. '78)

INGHAM $8\frac{1}{2}$ " x $4\frac{3}{8}$ " x $2\frac{1}{2}$ "

INGHAM

1201 single panel one side, letters incised
(Snydale, 3. 9. '78)

L F C^o LTD 9 " x $4\frac{1}{2}$ " x $2\frac{1}{2}$ "

L F C^o LTD

1202 stamped one side, letters incised
(Snydale 3. 9. '78)

ACCRINGTON

ALTHAM COLLIERY CO (1924) LTD

ALTHAM COLLIERY CO
(1924) LTD
ACCRINGTON

11897 plain fine brick, no panels, 7lbs
letters stamped (incised) copybook B/burn. (26. 9. '78)

F. Plain fine brick $7\frac{3}{4}$ " x $4\frac{1}{2}$ " x $2\frac{1}{4}$ "

1247 no panels F incised (6lbs).
(Snydale 1. 10. '78)

F

DYKEHEAD Dykehead Firebrick Wks, Bonnybridge
Stirling 1920/30 - 1960's

1258 plain fine brick, letters stamped
(Mr Spencer - Rlyw Pres. Soc) (2. 10. '78)

DYKEHEAD

CINDRILS

1259 plain fine brick - letters incised (large)
(Mr Spencer - Rlyw Pres. Soc) (2. 10. '78)

CINDRILS

DOUGALL (9lbs)

1260 plain fine brick - letters incised.
(Mr Spencer - Rlyw Pres. Soc. 2. 10. '78)
Bonnybridge - Stirlingshire 1884.

DOUGALL

ALITE D

✓ 1270
x

plain fire brick, no panels
letters (large) incised (Wombwell 8.10.78)
(Price Pearson Refractories Ltd, Brunley Hill Staffs.)

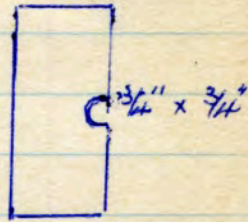
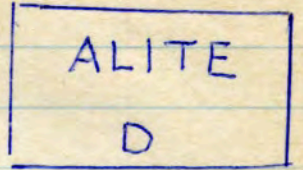

✓ 1296
x

no name. 9 1/2" x 6 1/2" x 3"
fine brick from Bakery Oven (Burneys).
(Dodgson St. dem. R/dale. 5. 11. 78)
3/4" channel along one face.

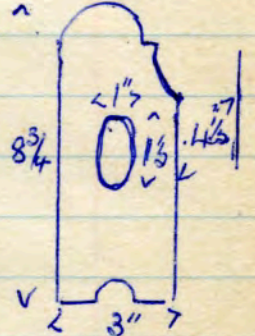

✓ 1297
x

decorative segment of moulding, part
of sign for Bakery Repton, near S P L
Spinning Mill 5. 11. 78

Glenboig Star Tinclay Wks, Glenboig, Lanarkshire
1936 - 1950.

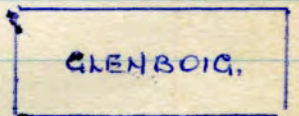

✓ 1305
x

plain fire brick, stamped one side
(Petre St. dem. ^{Clayton by Hoors} hen's backed meat factory 10.12.78)
no name (Glenboig? same boiler as above)

✓ 1306
x

plain fire brick 9" x 4 1/2" x 3"
(Petre St. dem. hen's backed meat factory. 10.12.78)

BURN AXE (^{Newcastle on Tyne} ^{Gunn Tinclay Co Ltd} ^{Stobwood Works (works)})

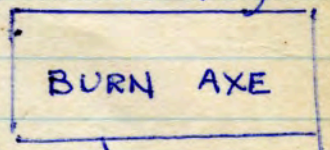

✓ 1317
x

plain fire brick, no panels
letters incised (Wigan W/rt Road. 25. 2. 79).
ALUMAN? (broken away)

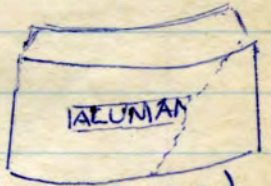

✓ 1330
x

cambered fire brick
letters incised on one edge, no panel
(S. Spencer - Cotton Cellulose Wks, R/stall 27. 3. 79)

ADAMANTINE CLINKER REG. (2 lbs)

✓ 1331
x

high class stable floor brick (purpose made)
yellow. 6" x 2 3/8" x 1 7/8", stamped one end.
(Reedyford Hall (stables) - present Hospital. 29. 3. 79)

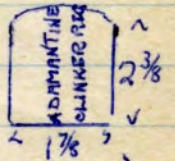

✓ 1339
x

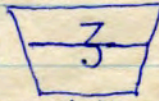
no name, no panel. "8 3/4" x 4"-3" x 3"
special cast fire brick, stamped  on end.
Found at Thos Temperley's stock yard 3" (15. 4. 79)

✓ 1340 x
 No name. No panel. $8\frac{3}{8}'' \times 4\frac{1}{4}'' \times 3''$
 Special cast, semicircular fire brick.
 Found at Thos Temperley's stock yard 15. 4. 79.

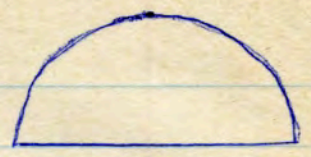

✓ ~~1341~~ cancelled see Foreign
 BORGESTAD 74C SYRST *see foreign*
 tapered fire brick $9\frac{3}{4}'' \times 4\frac{7}{8}'' \times 2\frac{1}{8}''$ taper to $2\frac{3}{8}''$
 Letters incised in faint oval panel.
 (S. Spencer - 18. 4. 79 - Constablee).
 see also Foreign Bricks - Norway.

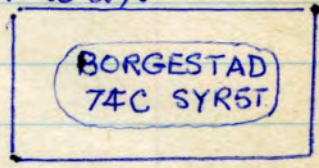

✓ 1342 +
 COWEN M
 plain fire brick $9'' \times 4\frac{1}{2}'' \times 3''$
 no panels. letters incised (Mrs Hos 18. 4. 79)

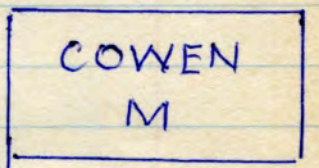

✓ 1372 +
 P R 40
 plain fire brick $8\frac{3}{4}'' \times 4\frac{1}{4}'' \times 3''$
 no panels. letters incised
 (S. Spencer. London 29. 4. 79)

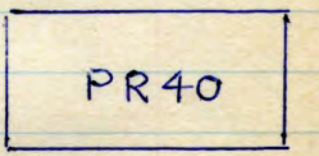

✓ 1402 x
 CO
 plain fire brick, letters deeply incised
 in faint stamped circle. no panels
 (S. Spencer, Laund hill. Constablee, R/stall. 4. 5. 79)

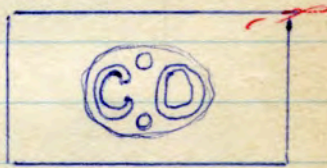

✓ 1406 x
 PEASE $9'' \times 4\frac{1}{2}'' \times 2\frac{1}{2}''$
 plain fire brick, double incised letters in
 stamped rectg/n surround. $5\frac{3}{4}'' \times 1\frac{3}{4}''$
 (Mrs Hos. 12. 5. 79) (Rosedale, N. Yorks.)

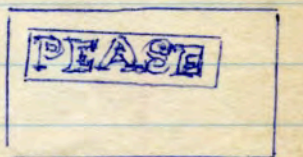

✓ 1404 x
 PEASE $9\frac{1}{2}'' \times 4\frac{1}{2}'' \times 3''$ (Buddling^{beach} 'air)
 rectg/n panel $\frac{1}{2}''$ deep with name obo.
 oval panel $1\frac{1}{2}''$ " plain $4'' \times 2\frac{3}{8}''$ rev.
 double incised letters (Mrs Hos - 12. 5. 79)

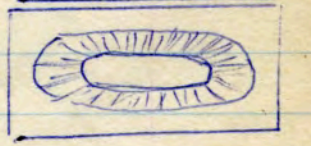
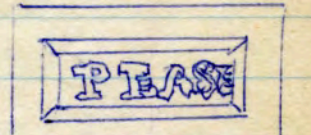

✓ 1408 x
 C & M $9'' \times 4\frac{1}{4}'' \times 2\frac{1}{2}''$
 plain fire brick, letters double incised
 in stamped rectg/n. $4\frac{3}{4}'' \times 1\frac{1}{2}''$
 (Mrs Hos 12. 5. 79)

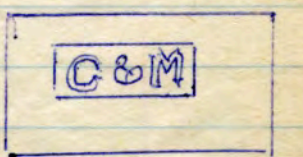

✓ 1409 x
 G $9'' \times 4\frac{1}{2}'' \times 2\frac{1}{2}''$ (small)
 plain fire brick - letter incised clear.
 no panels. (Mrs Hos 12. 5. 79)



WC & CO 9" x 4 1/4" x 2 3/8"

1410 ✓
x

plain fine brick, letters deeply incised in stamped rectangle 6" x 1 1/2"
(Mrs Hos. 12. 5. 49)

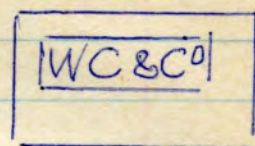

N B (with thumb mark) 9 1/4" x 4 1/2" x 3"

1411 ✓
x

no panels. letters incised, indistinct

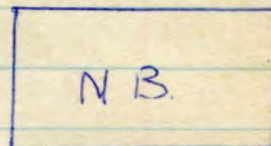

(Mrs Hos 12. 5. 79)
Glenboig Star Fireclay Works, Glenboig, Lanark. 1836 - 1950
GLENBOIG 9" x 4 1/2" x 3" fine brick

1431 ✓
x

no panels, name stamped one side
(J. Harrison. Waterbarn Mill. 24. 6. 79)

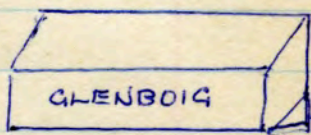

G plain fine brick.

1432 ✓
x

no panels. large double letter, stamped. clear.
(S. Spencer. 23. 6. 79)

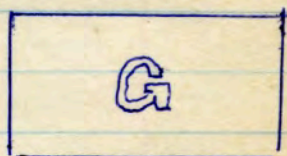

POTTER 2 9 5/8" - 8 3/4" x 4 1/2" x 2 1/2"

1438 ✓
x

cambered fine brick. no panels
letters incised. (Gosmont. J. J. Dunwell)
(Mrs Hos. 1. 4. 49)

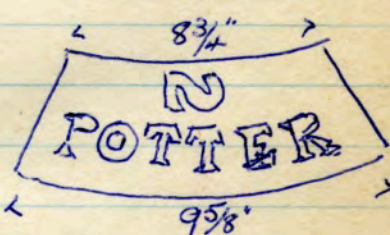

BROOMHILL 8 3/4" - 6 7/8" x 4 1/2" x 2 3/8"

1439 ✓
x

cambered fine brick. no panels
letters stamped. (Comhill on Tweed)
(Mrs Hos 1. 4. 49)

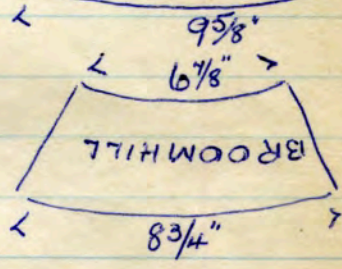

AA

1455 ✓
x

no panels. plain fine brick.
(presumed Turner's Asbestos - similar markings on their packages).
S. Spencer.

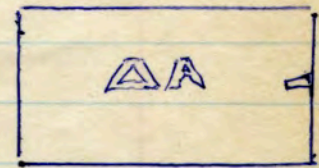

C. K. HARRISON STOURBRIDGE 2 1/2"

1444 ✓
x

gauged arch starter brick. 9" x 4 1/4" x 3" - 2 1/2"
stamped in rect. panel one side. 2 1/2" on edge
(J. Temperley's "top shop". 28. 4. 49)

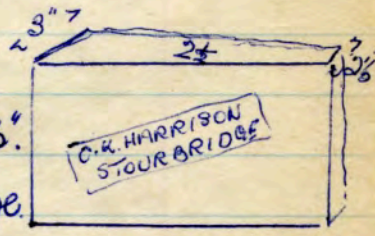

W plain fine brick 9" x 4 1/2" x 3"

1478 ✓
x

stamped one side. no panels.
(J. Temperley's "top shop" 28. 4. 49)

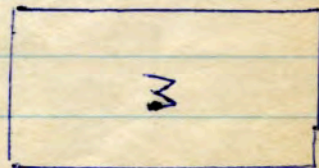

W L plain fine brick.

1449 ✓
x

no panel, stamped one side.
as 1477 & 1478

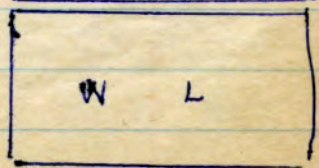

1495 ✓
 No name, plain white fire brick.
 9" x 4 3/8" x 2 3/8" (Mrs Hos) 22. 7. 79.
 from Heathfield Mill (built 1850s) Pateley Bridge Caravan site

1496 ✓
 No name, bull nose fire brick, large radius.
 (Mrs Hos - found at Embury Station. 22. 7. 79).

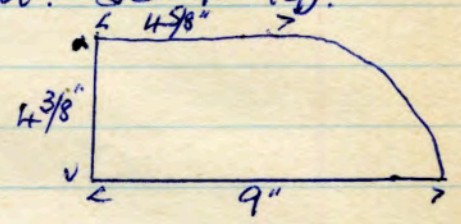

1509 ✓
 R B C letters incised 9" x 4 1/2" x 2 3/8"
 plain fire brick, no panels.
 (Mrs Hos - 22. 7. 79.)

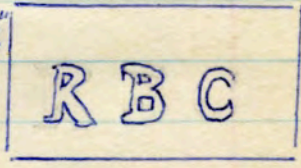

1519 ✓
 N C A P 9" x 4 3/8" x 2 1/2"
 fine brick, small single panel
 obverse only. letters roughly incised

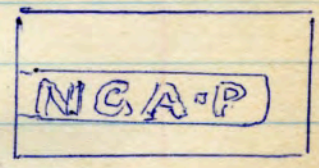

(Brompton's Brick Kiln, Croxson 5. 8. 79)
 (1923) Wrose Hill Fine Loyal Co Ltd Carr Lane Shipley
 W H F C C O L D SHIPLEY 9" x 4" x 3"

1536 ✓
 fine brick, single panel each side
 letters incised, one side only.
 (Wyke. Elec. dumping ground. 26. 8. 79)

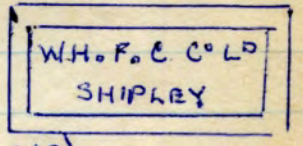

GLENBOIG S 9" x 4 1/4" x 2 1/2" - 1 1/2"

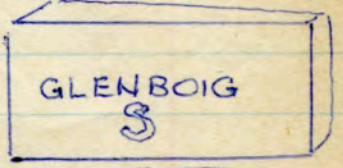

1660 ✓
 gauged arch brick for boiler flue.
 (R/stall Electricity Wks. 10. 1. 80) (J. Davies)
 No name (Glenboig?) 8 3/4" x 4 1/2" x 3"

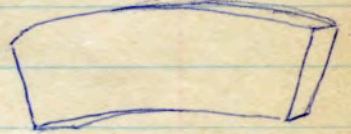

1661 ✓
 cambered fire brick
 (R/stall Electricity Wks. 10. 1. 80. J. Davies)
 12 A STARWORKS GLENBOIG J D

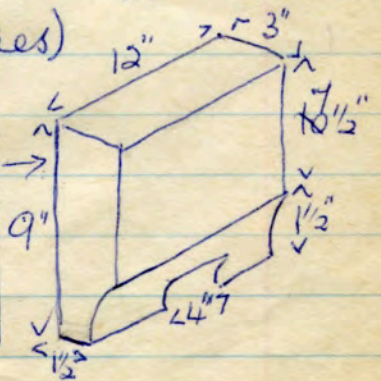
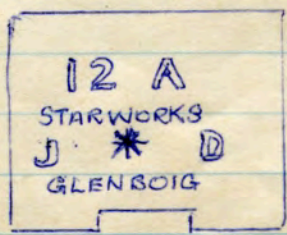

1662 ✓
 12" x 9" x 3" - 1 1/2"
 (R/stall Electricity Wks 10. 1. 80. J. Davies)

Glenboig Star Tuesday Wks. Glenboig
 Lanarkshire. 1836-1950

No name (Stein or Glenboig) 9" x 4 1/4" x 2 7/8" - 2 1/4"
Used for lining rings of Lancs boiler furnace
on pulverised coal firing.

Slot 2" x 3/8" for metal ring.
(Mr. N. Taylor, Chadderton 24. 2. 80)

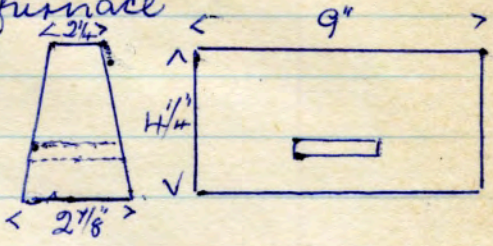

1691
x

No name. Found near to Morden
Bk. Wks. Rishton, so presume to have
been made by G. Clarke & Sons, Rishton.

8 1/2" x 4 1/8" x 2 3/4" fire brick with 10 perfs.
5 x 3/4" diam, 5 x 1/2" diam. Covered with salt glaze as a
result of being used as a support in the kiln.
(9 lbs). (8. 3. 80)

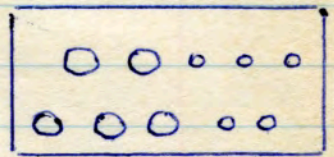

1720
x

G C R no panels 8 3/4" x 4 1/8" x 3"
letters deeply incised 10 lbs.

(G. Clarke & Sons Morden Fire Clay Wks. Rishton)
(Int Harwood Gas Works. 9. 3. 80)

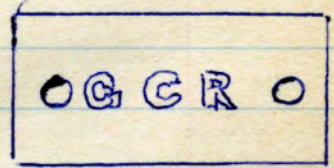

1726
x

NIGHTSTOR 11 3/4" x 4 1/2" x 4 3/4" 17 1/2 lbs.

fireclay storage heater block, no panel, letters incised

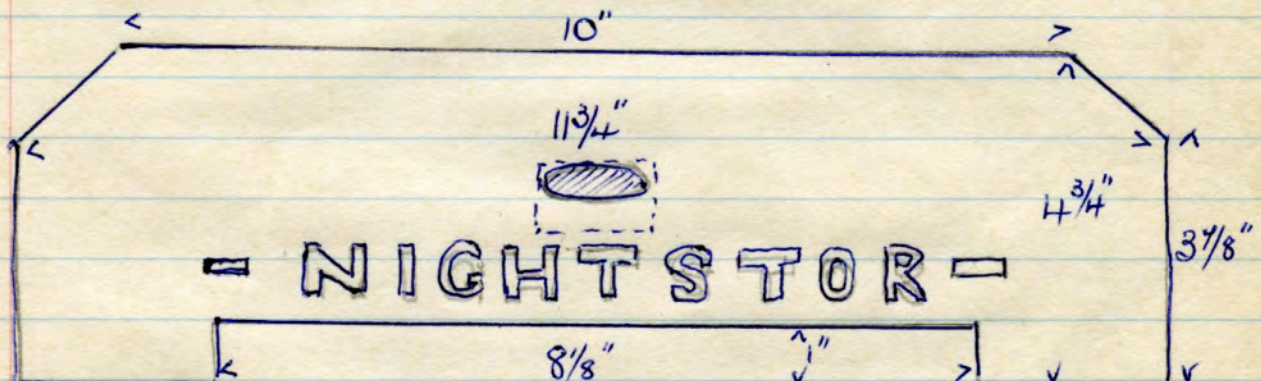

1743
x

1 perf. 7/8" x 1/4" Lip at Snowden & Bridge. W/foot 8. 1. 80

FRONT ELEVATION.

1744
x

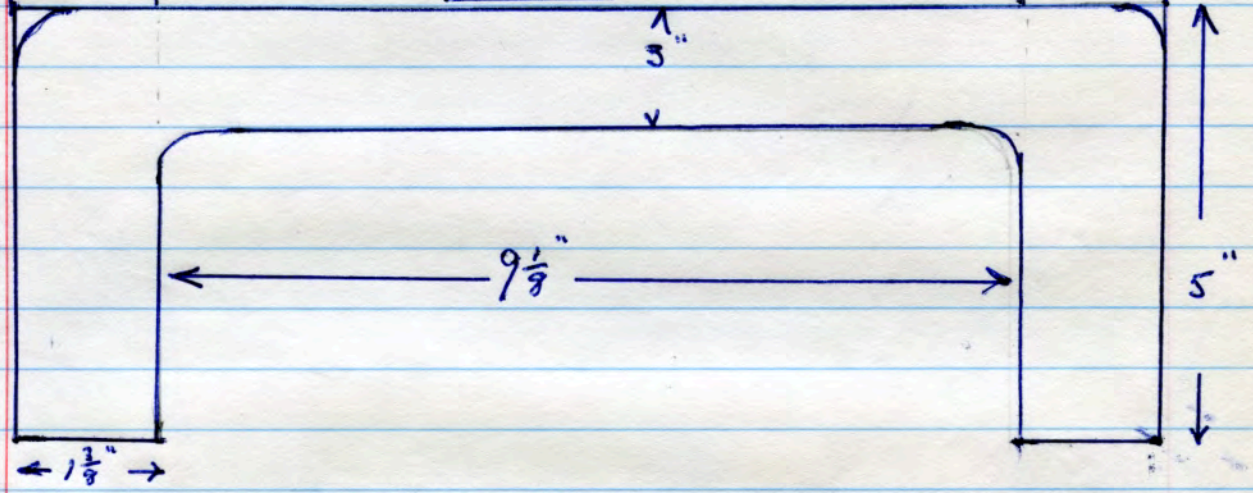
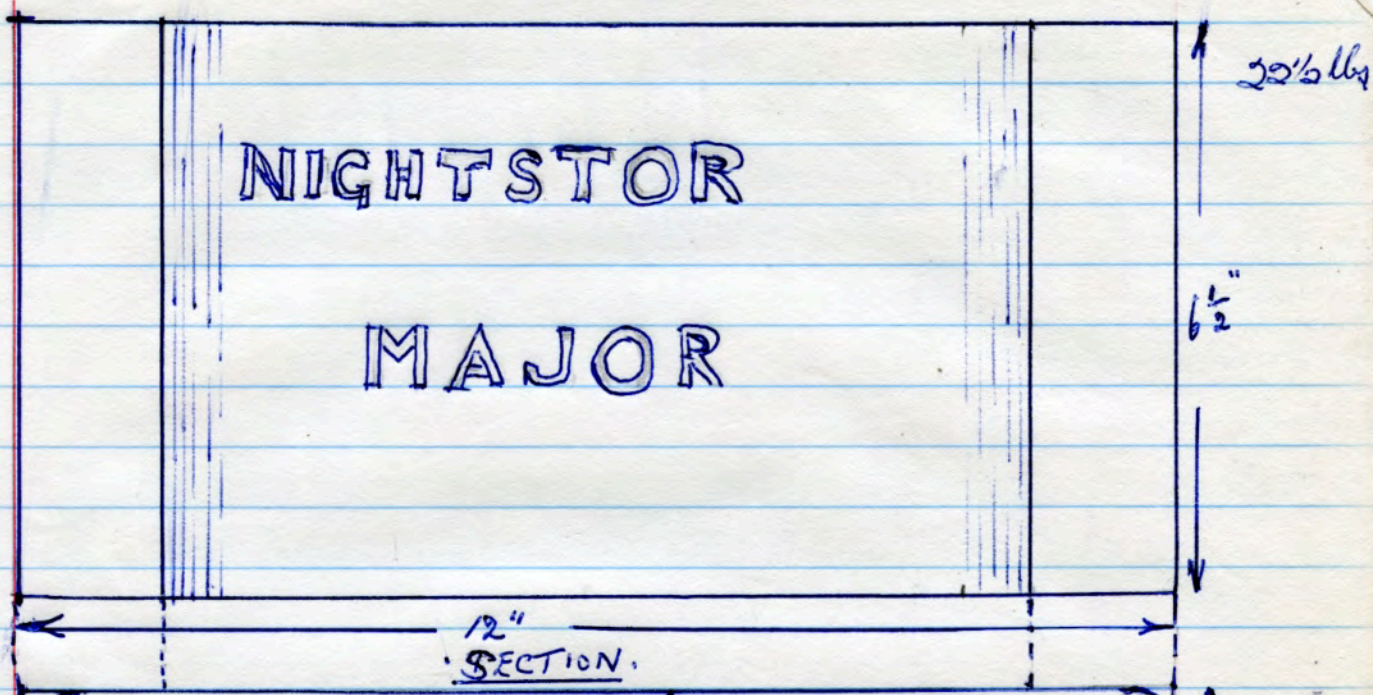

26 3/4"
FRONT ELEVATION.

1745
x

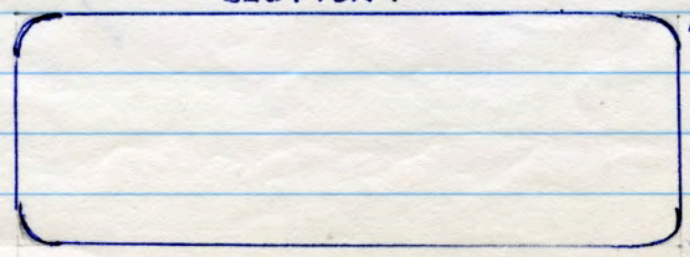
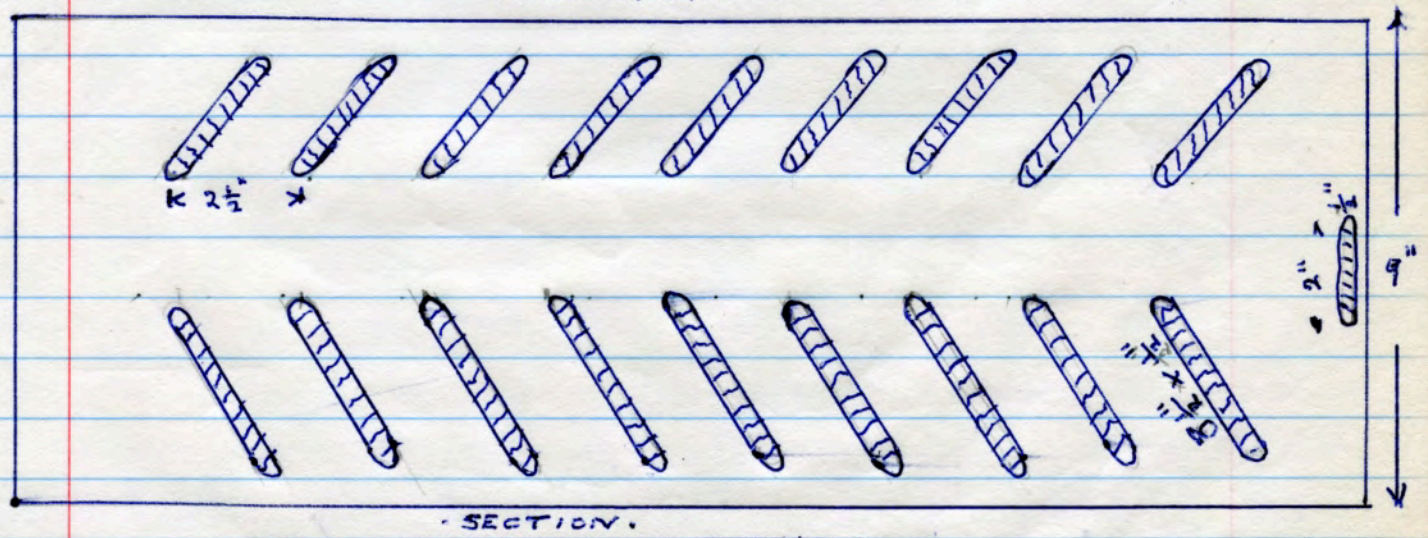

" Triclay storage
3 3/4 heater block (with
wires) no name, no
panel. As 1443 + 44.

✓
1748
x

no name, no panels, red showing spar.
storage heater brick. 9 lbs.

Ross Gen Hospital H. 3. 80.

depth $2\frac{3}{4}$ " 2"

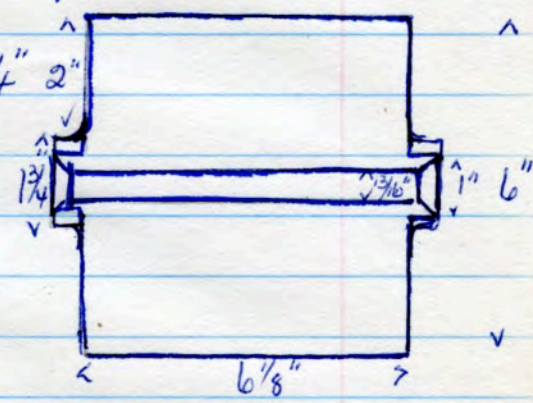

1444
x

G x G $4\frac{3}{4}$ " x $4\frac{1}{2}$ " x $2\frac{7}{8}$ " 6 lbs.

no panels, stamped 1 side only
one end severely burnt, was originally 9"
S. Spencer, brawshawbooth. 15. H. 80.

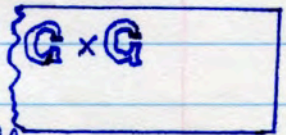

Glenboig Star Thursday Wks, Glenboig, Lanark
GLENBOIG 6 lbs 1836 - 1950

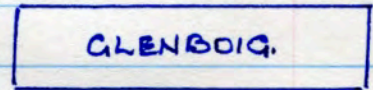

1745
x

Stamped 1 side. 9 " x $2\frac{7}{8}$ " x $2\frac{3}{8}$ "
Ince in Makersfield. 13. H. 80.

GIBBONS & MASTERS PATENT N° 16258
hearth flag 17 lbs.
S. Spencer, brawshawbooth. 15. H. 80.

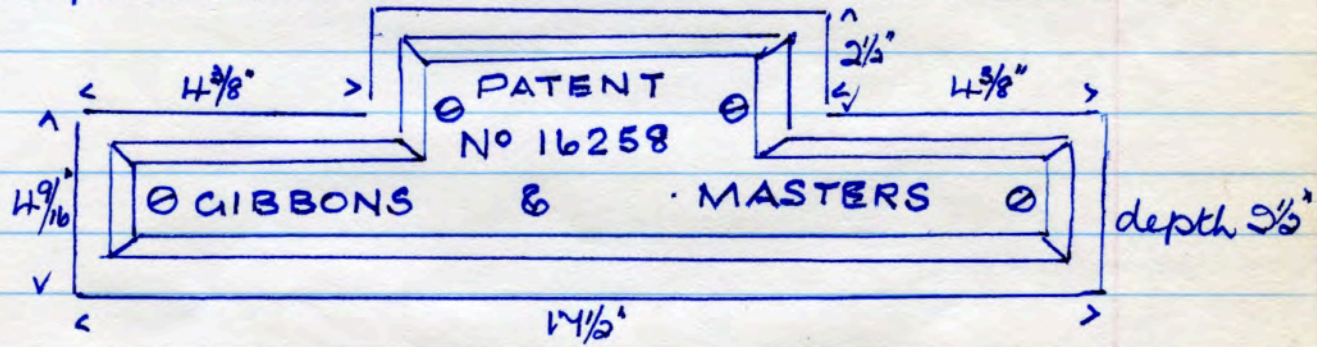

1776
x x x

x 1805
x

ENTWISLES LIMITED DARWEN 9 " x $4\frac{1}{2}$ " x 3 "
single panel $\frac{1}{2}$ " deep $6\frac{1}{2}$ " x $2\frac{3}{16}$ " each side
letters incised obv. only $7\frac{1}{2}$ lbs.
High Street, Ince. 20. H. 80.

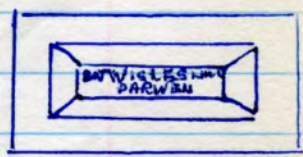

Stein-late 19th

4829 ↑ ◦ NETTLE ◦ 11 lbs

gauged fire brick. 9" x 7 1/4" x 2 7/8" - 2".

stamped 1 side. sand colour.

Ladyshore, Little Lever 24. 4. 80.

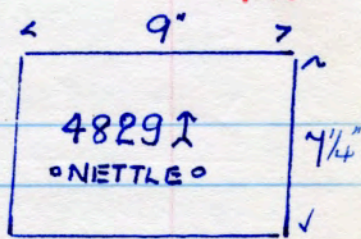
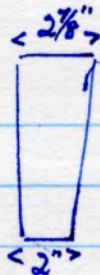

7Q

1807

No name. Storage heater brick.

11 lbs 8 3/4" x 5 7/8" x 2 3/4" white

Manchester Rd, Wigan 13. 4. 80.

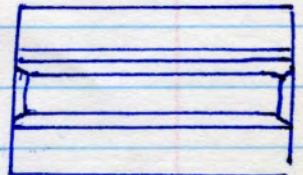

1808

H57--1003 D red. 8 3/8" x 1 7/8"

part, storage heater brick

6 lbs Manchester Rd, Wigan. 13. 4. 80.

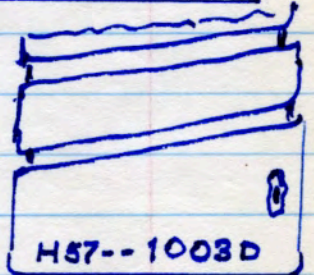

1889 - 1980.

Hurlb k. G. Carrnqueen fireclay Wks. Glenboig.
HURLL K plain fine brick, no panel
letters incised. 9" x 4 1/2" x 3" 8lbs.

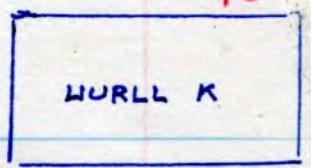

✓ 1828 ✓
✓ x

Guide Street, house dem. 27. 4. 80. (Glasgow).

THISTLE G glazed yellow fire brk
no panel, incised letters
8 lbs 9 1/8" x 4 3/8" x 3" - 2 1/2"

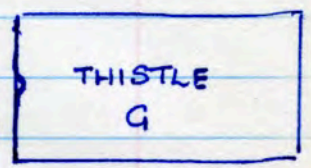

✓ 1845 ✓
✓ x

Guide Street, house dem. Weaste.
H. 5. 80. (G. R. Stein).

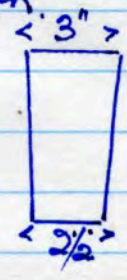

C storage heater block 9 1/2" x 6" x 2 3/4"
14 lbs. letter incised. beige colour.
Guide Street, house dem. Weaste 4. 5. 80.

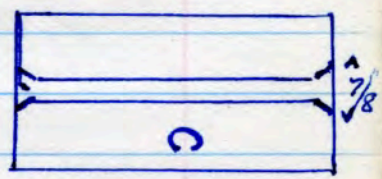

✓ 1846 ✓
✓ x

ADAMANTINE CLINKER. REC
high class stable floor brick
(purpose made) yellow 2 lbs.

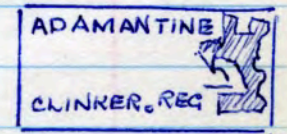

6" x 2 7/10" x 1 3/4" stamped on base
S. Spencer, Upper Brock St. Mfr. 14. 5. 80.

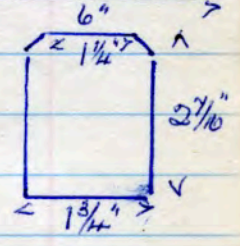

✓ 1874 ✓
✓ x

1893-1936. Robert Brown & Son, Paisley. Ferguslie fireclay Wks. Renfrew.
BROWN PAISLEY. 9 lbs. 9" x 4 3/8" x 3"

single small panel each side
letters tiny incised obv. only.

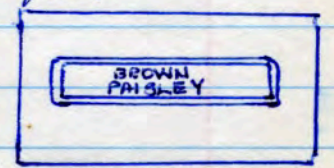

✓ 1899 ✓
✓ x

braithwaite's B & Pipe Wks, Upper Norwich. 1. 6. 80.

HURLL F fine brick, orange with purple speckle.
no panel, letters incised 9" x 4 1/2" x 3"
8 lbs. (has probably been cut to shape)



✓ 1930 ✓
✓ x

Knabtree Lane, Droylsden 15. 6. 80.

✓ 1984 ✓
✓ x

GIBBONS (DUDLEY) LTD ALUMINOUS W.
fine brick, no panels, letters incised
7 1/2 lbs 9" x 4 3/8" x 3"

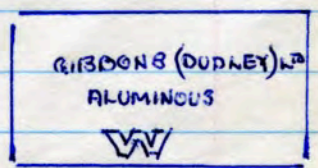

S. Spencer. 22. 6. 80

✓
2003
x

BUCKLEY JUNCTION 6lbs $9\frac{1}{4}'' \times 4\frac{3}{8}'' \times 2''$
plain fine brick, letters incised $\frac{7}{8}''$ high.
Mr Deakin (Loveclough) from

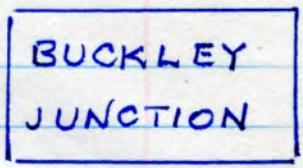

✓
2004
x

JUNCTION BUCKLEY 6½ lbs. $9\frac{1}{8}'' \times 4\frac{5}{16}'' \times 2\frac{1}{16}''$
plain fine brick. letters incised
JUNCTION $1\frac{1}{8}''$ high BUCKLEY $\frac{7}{8}''$ high.
Mr Deakin (Loveclough).

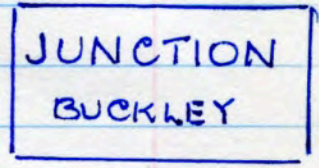

No name (Bispham Hall) fireclay bricks w/o kiln
 $9\frac{1}{8}'' \times 4\frac{1}{2}'' \times 3\frac{1}{8}''$ 10 lbs

single panel each side.

✓
2005
x

Bispham Hall Brk Wks. Smethurst Rd.
Ornell 6. 7. 80

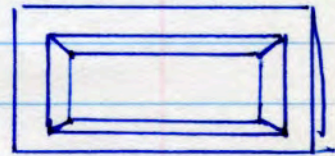

✓
2006
x x

POULTON & SON plain fine brick used
as building brick (Bispham Hall Brk Wks).
letters incised, no panels 7 lbs. $9'' \times 4\frac{1}{2}'' \times 3\frac{3}{4}''$
Bispham Hall Brk Wks, Smethurst Rd, Ornell. 6. 7. 80.

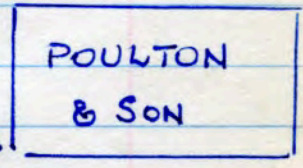

 no panels, plain fine brick.
 $8\frac{7}{8}'' \times 4\frac{1}{4}'' \times 3''$ 9 lbs.



✓
2099
x

Longport Indus. Estate tip 20. 7. 80.

✓
2091
x

RUFFORD STOURBRIDGE
8 lbs. $9'' \times 4\frac{3}{8}'' \times 2\frac{3}{4}''$
no panels, letters incised
Longport Indus. Estate tip 20. 7. 80.

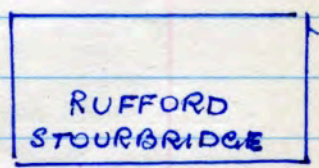

✓
2092
x x

G 93 AA no panels
6 lbs $8\frac{7}{8}'' \times 4\frac{1}{4}'' \times 2\frac{5}{16}''$.
letters incised $3\frac{3}{4}'' - 3\frac{5}{8}''$ deep.
Longport Indus. Estate tip 20. 7. 80

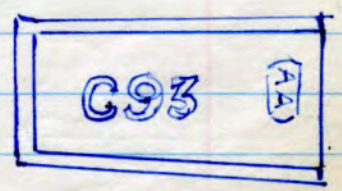

✓
2153
x x

✓
SNEYD COLLIERY BURBLEM BB.
8 lbs. $9\frac{1}{4}" \times 4\frac{3}{8}" - 3\frac{3}{4}" \times 3"$
no panels, letters stamped 1 side.
Newton Heath Bk Yard. 7. 9. 80.

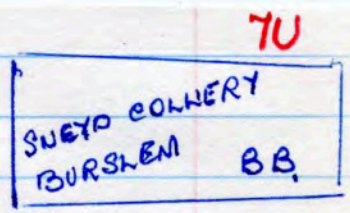

✓
2155
x x

✓
SHAWS BLACKBURN
9 lbs. $9" \times 4\frac{3}{8}" \times 3"$
single panel each side, letters incised
one word each side.
Duchess St. Gt blowes M/r. 7. 9. 80

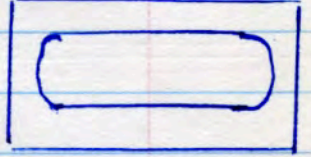
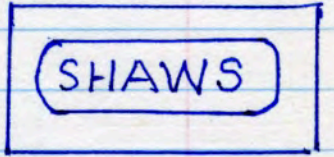

✓
2165
x x

✓
BIGELOW. EMPIRE
2 lbs. $6\frac{13}{16}" \times 6\frac{1}{8}" \times \frac{1}{16}"$
presumed alumina linet
Duchess St. M/r. 7. 9. 80

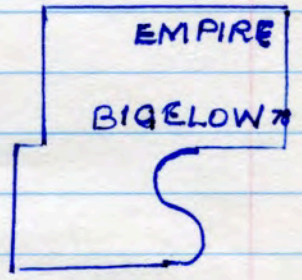

✓
2193
x x

✓
no name, no panels
Rebated fire brick
7 lbs. $8\frac{1}{4}" \times 4\frac{1}{8}" \times 2\frac{1}{8}"$
Albany hill dem site, Oldham 14. 9. 80.

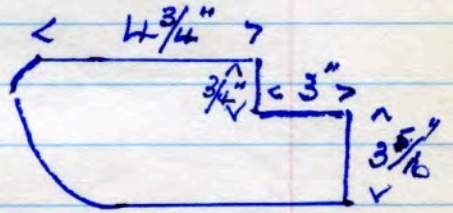

✓
2225
x x

✓
DOUGLAS D gauged fire brick
7 lbs $9" \times 4\frac{5}{8}" \times 3" - 2"$
name stamped 1 side.
blair's laundry dem. Balderstone 14. 9. 80.

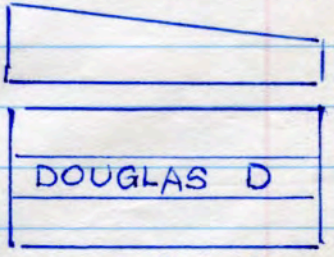

✓
2226
x x

✓
1759 as above 2225, (without name)
7 lbs. $9" \times 4\frac{1}{2}" \times 2\frac{1}{8}" - 2\frac{1}{8}"$

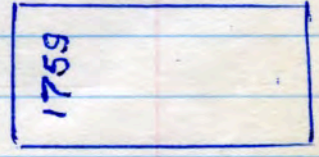

✓
2227
x x

✓
1759 gauged opp way. as above
7 1/2 lbs. $9" \times 4\frac{3}{8}" \times 2\frac{1}{8}" - 2\frac{1}{2}"$
blair's laundry dem. Balderstone 14. 9. 80

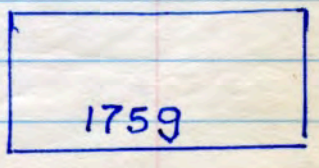
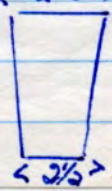

HURLL plain fire brick (orange)
9 lbs. $9\frac{1}{4}'' \times 4\frac{1}{4}'' \times 3''$

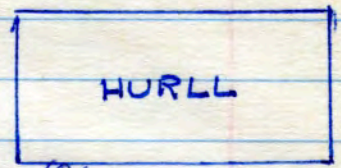

2245 ✓
x x ✓

no panels, letters incised.
Waterloo Rd. Crumpsall. 12. 10. 80. (Glasgow)

F L plain fire brick (yellow)
8 lbs. $9'' \times 4\frac{3}{8}'' \times 2\frac{1}{8}''$

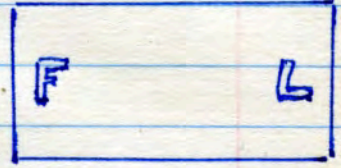

2246 ✓
x x ✓

no panels, letters incised
Waterloo Rd. Crumpsall. 12. 10. 80

no name, no panels, plain fire brick.
7 lbs. $8\frac{7}{8}''$ to point $\times 4\frac{3}{8}'' \times 2\frac{1}{8}''$ 26. 10. 80.
Wallness School dem. Frederick Rd. M/r.

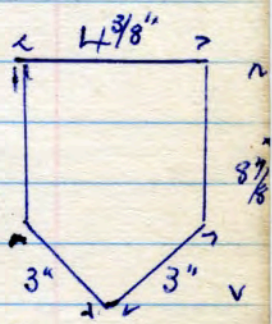

2267 ✓
x x ✓

DETRICK LSP 7135 93 EMP

$13\frac{1}{8}'' \times 4'' \times 2\frac{1}{8}''$ furnace lining
Kiptak Bradley Ltd, Industrial
Furnace Enclosures, 19. 10. 80.
Broughton Lane. Lt Broughton M/r.
18 lbs.

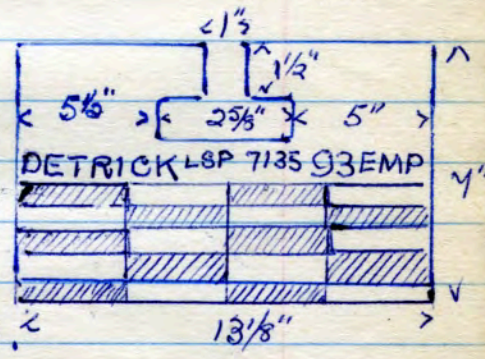

2243 ✓
x x ✓

CALDER.

9 lbs. $8\frac{7}{8}'' \times 4\frac{3}{8}'' \times 2\frac{5}{16}''$

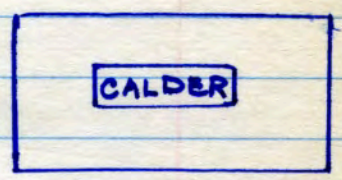

2293 ✓
x x ✓

name stamped in small panel obs.
brankshaw's dem. Horwich 12. 11. 80

M gauged arch kiln brick.

9 lbs. $9'' \times 4\frac{3}{8}'' - 4\frac{1}{8}'' \times 3''$

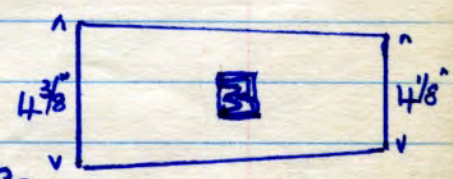

2294 ✓
x x ✓

letter stamped 1 side.
brankshaw's dem. Horwich. 12. 11. 80.

(Henry Foster Bldg Products, Bishop Auckland)

H G FOSTER W4 gauged fire brick

8 lbs 8 3/4" x 4 7/8" x 3" - 2 1/4"

no panels, letters incised.
brankshaw's dem. Howich. 12. 11. 80

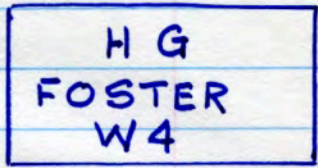

2295
x x

FEROUBLIE ON LTD

gauged fire brick 7 lbs 8" x 3 3/4" - 4 1/4" x 2 7/8"

small oval panel, letters incised (faint).

coated with kiln burning

brankshaw's dem. Howich. 12. 11. 80

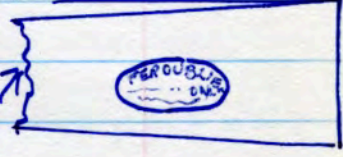

2296
x

N B plain kiln brick.

13 lbs. 8 5/8" x 5 3/4" x 2 3/4"

no panels, letters incised clear
brankshaw's dem. Howich. 12. 11. 80

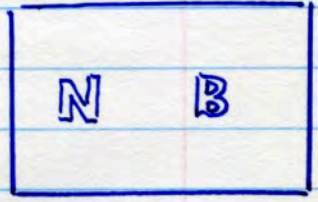

2297
x x

No name (made by brankshaw's) fire clay
used as a building brk in retaining wall.

20 lbs. 15" x 4 1/2" x 4"

part salt glazed 1 side

brankshaw's dem. Howich 12. 11. 80.

marks show where 3 brks have been laid.

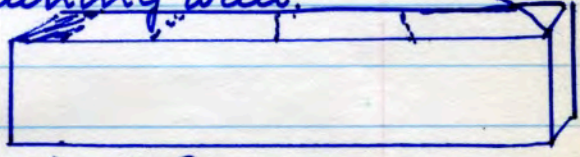

2298
x x

W plain fire brick

no panels, letter incised.

8 lbs. 8 7/8" x 4 1/4" x 2 7/8"

Jackson's, Mouslow Quarry, Glossop. 2. 11. 80

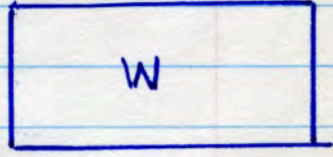

2311
x x

No name, no panels.

4 1/2 lbs 9" x 2 7/8" x 2 7/8"

Jackson's, Mouslow Quarry, Glossop. 2. 11. 80



2312
x

Fireclay kiln rest or heat baffle. No name. presumed made by Brankshaw's at Horwich.

18 3/4" - outside diam. rim = 2 1/4" thick
14 1/4" - internal " = 4" depth.

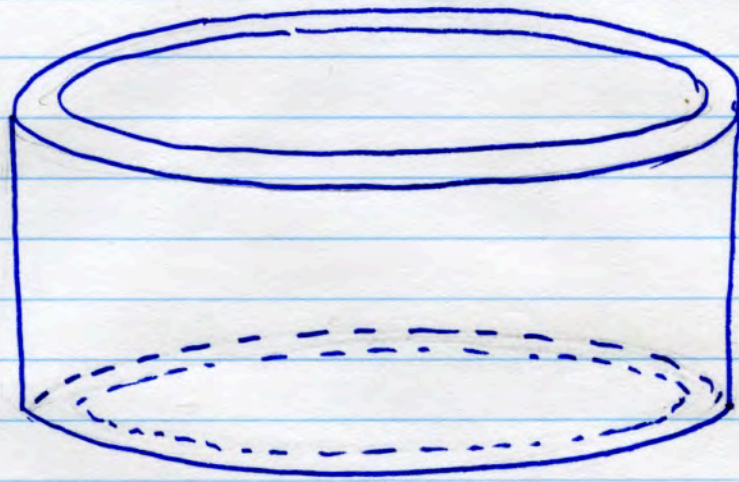

Glenboig Star Fireclay Wks, Glenboig, Lanark. 1836-1950

GLENBOIG 5 seating brick

7 lbs 8 5/8" x 4 3/8" x 2 3/4"

no panels, letters stamped.

Ringley coal Pit site, Radcliffe 23. 11. 80

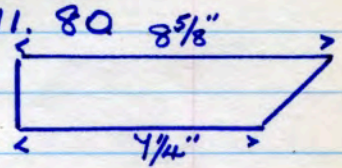
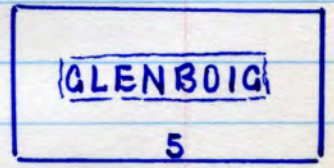

ATLAS + A gauged fire brick.

8 lbs 9" x 4 3/8" x 3" - 2 5/8"

no panels, letters stamped

Ringley coal Pit site, Radcliffe. 23. 11. 80.

(ATLAS + A = United Fireclay Products Limited)

No name.  stamped on one

8 1/2 lbs 8 1/16" x 4 5/16" x 3"

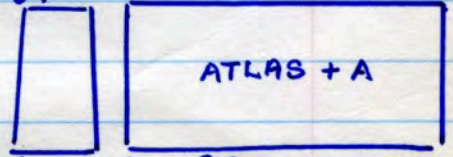

no panels. fire brick

Bombay Station nr Skipton 14. 12. 80.

KLINIT plain fire brick.

12 1/2 lbs 9" x 6" x 2 5/16"

no panels, letters incised

Bombay Station nr Skipton 14. 12. 80.

Garngreen Fireclay Wks, Glenboig, Lanarkshire



2314 ✓ x

2333 ✓ x

2334 ✓ x

2343 ✓ x

2344 ✓ x

A WORTLEY plain fire brick.

8 lbs. $8\frac{5}{8}" \times 4\frac{1}{4}" \times 3"$

no panels, letters incised

Embassy Station nr Skipton 14. 12. 80.

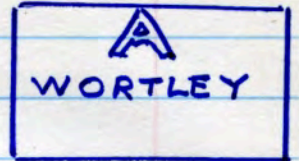

no name. brown with yellow mottle

18 lbs. $7\frac{1}{4}" \times 7\frac{1}{8}" \times 4\frac{3}{8}"$

ridged as for storage heater block.

brankshaw's fire clay wks dem. Horwich 11. 11. 80.
projects $\frac{1}{2}"$

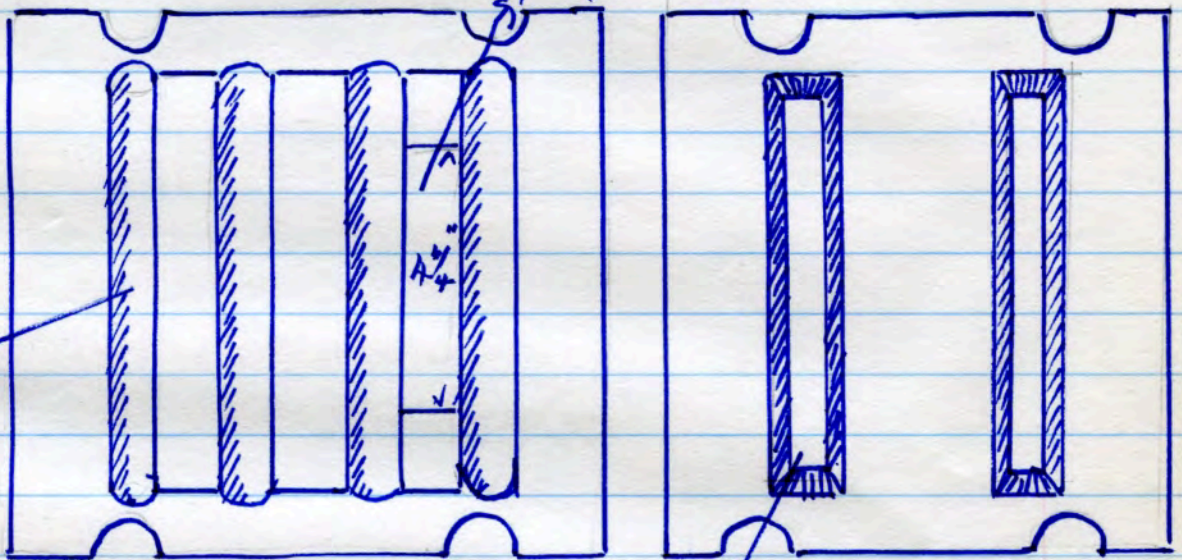

FRONT ELEVATION

rear $5/8"$ deep

no name, blue, open drain

14 lbs $12" \times 6" \times 3"$

no panels.

brankshaw's Horwich 11. 11. 80.

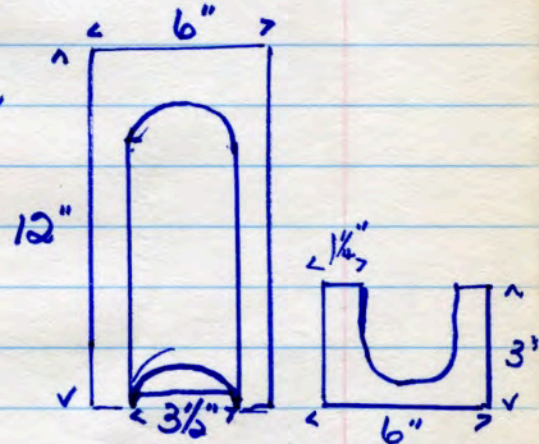

RAKE F B CO LITTLEBORO

8 lbs. $9\frac{1}{8}" \times 4\frac{1}{4}" \times 3\frac{1}{8}"$

single panel each side, letters incised
less Lane Rly siding (Windsor Rd).

21. 12. 80



2345 ✓ x

2357 ✓ x

2358 ✓ x

2378 ✓ x

-DUCKETTS= BURNLEY -PATENT-

Sanitary fitting (grate top + soil pipe combined)
 salt glazed fire clay 39 lbs. 14" x 14" x 3 3/8"
 name stamped on face edge.
 Brankshaw's Horwich. 7. 12. 80.

x 2363 ✓

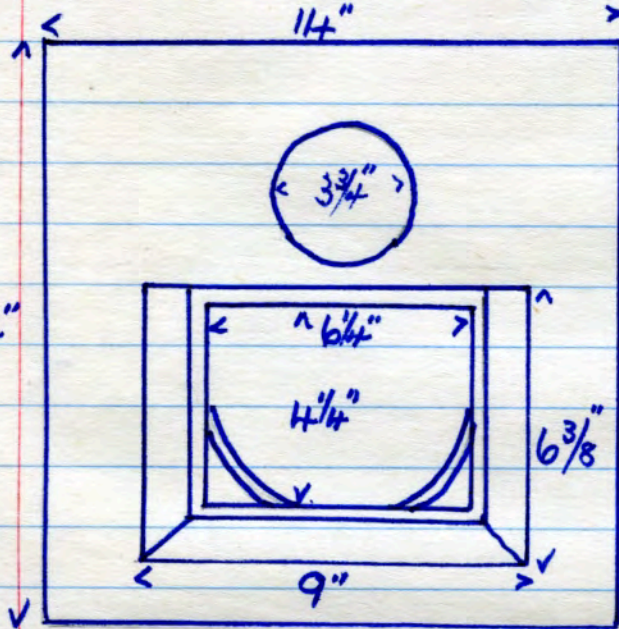

TOP

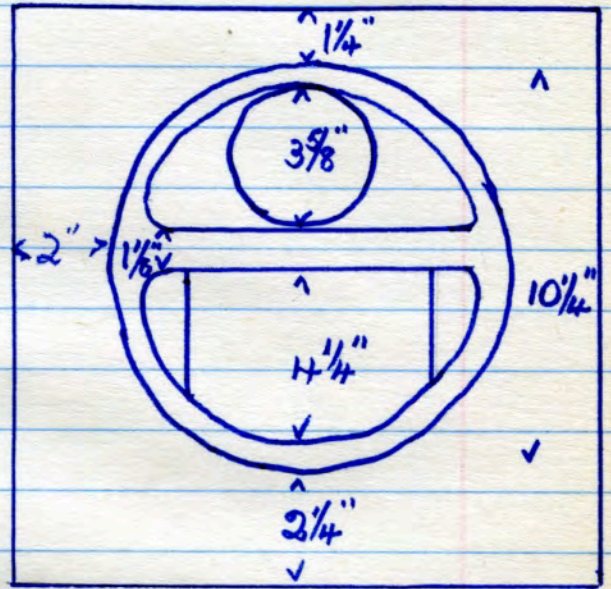

REVERSE

HF SI 9 flue brick (boiler) fire clay
 Henry Foster Building Products
 18 lbs 3/8" thick
 No panels, letters incised

x 2366 ✓

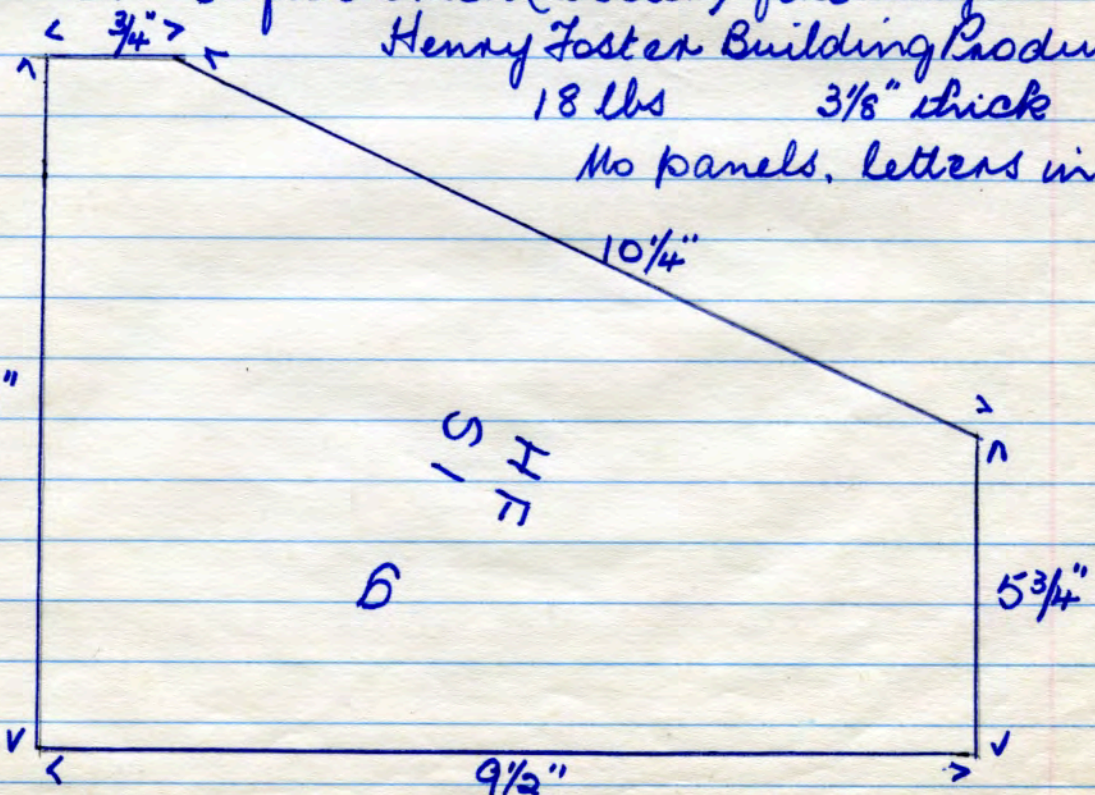

Albert: Wks dem (MASCOS) Burnley Rd East. W/foot 20.12.80

OAK 32
7 lbs

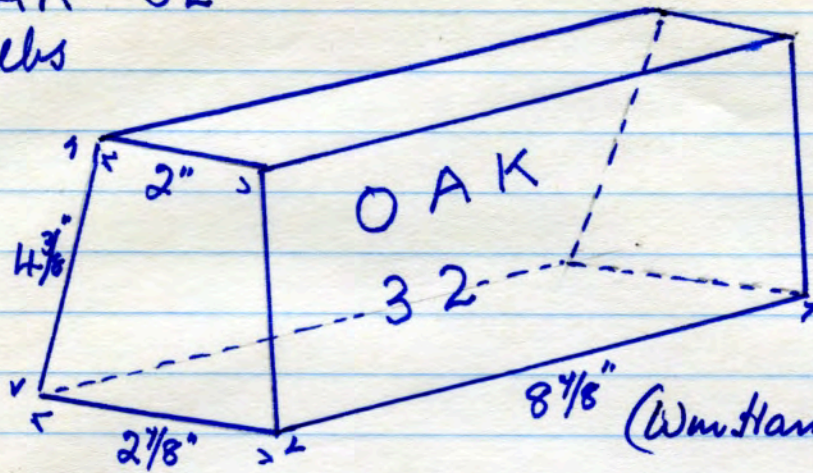

gauged fine brk
(arch)
no panels
letters deeply
incised.

Refractories),
(Wm. Hammond Ltd)

20.12.80

Albert Wks dem. (MASCO) Burnley Rd E. W/foot

CA

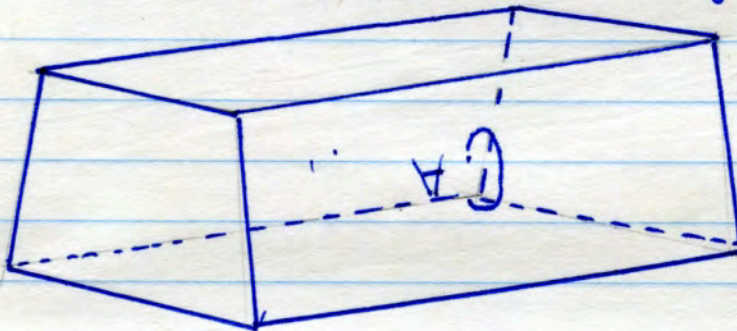

gauged arch fine
brick
no panels
letters incised

20.12.80.

Albert Wks. dem. (MASCO) Burnley Rd E. W/foot

No name, fine clay kiln grate.

36 lbs

12 1/2" x 12 1/2" x 4 1/2"

20 perfs. 1 1/2" diam. no panels.

brankshaw's Horwich 4. 12. 80.

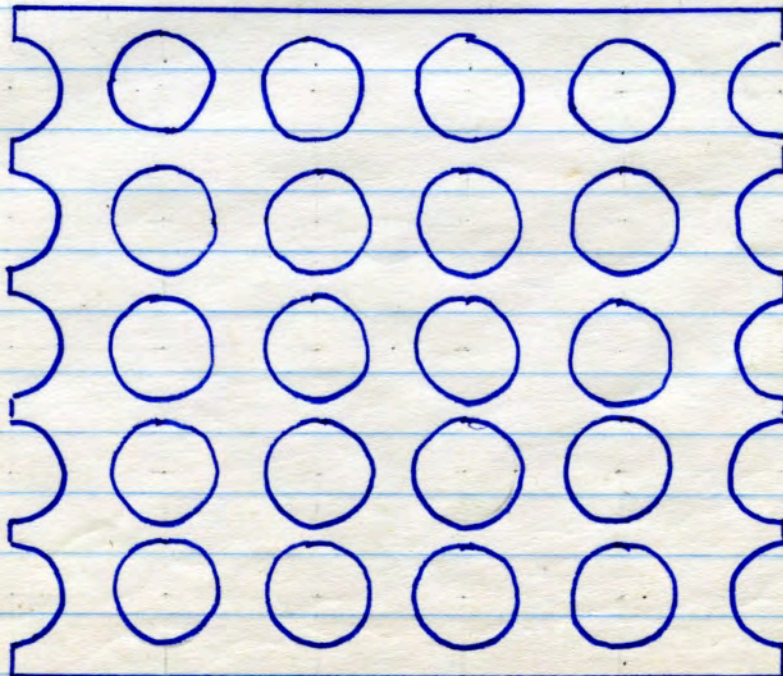

2367

2368

2374

No name. Salt glazed, fine clay floor tile
 11 1/2 lbs. 9 3/8" x 9 3/8" x 2"
 4 panels on rev. 3 1/2" x 3 1/2" x 1/4"

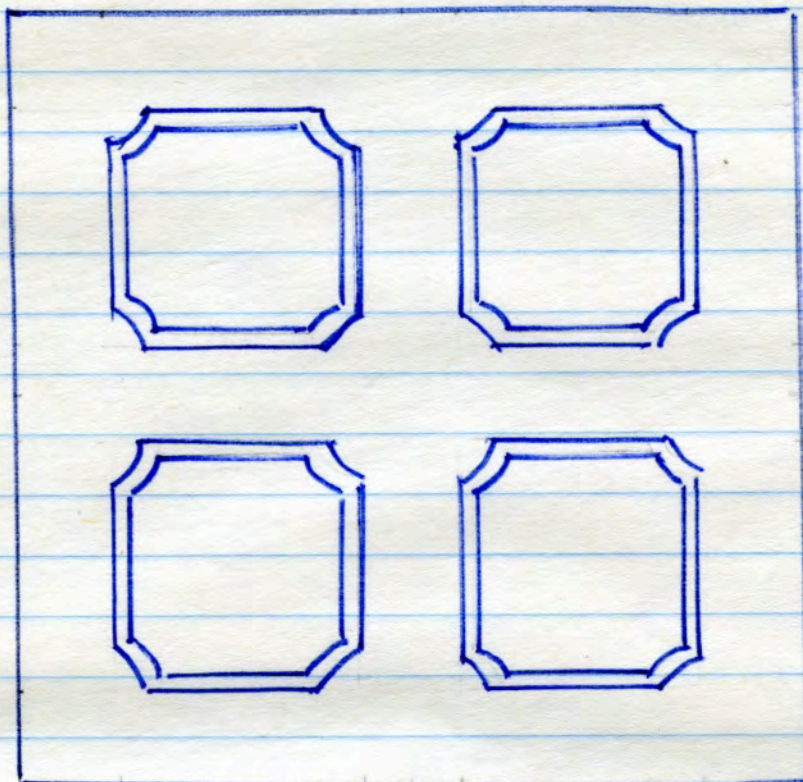

992^x
 no used from
 repeat

Duckett's dem. Blannel St. Burnley. 15. 2. 81.

No name, fine clay corbel. (broken)
 8 lbs. 9 1/2" x 6 3/8" x 3 1/8"

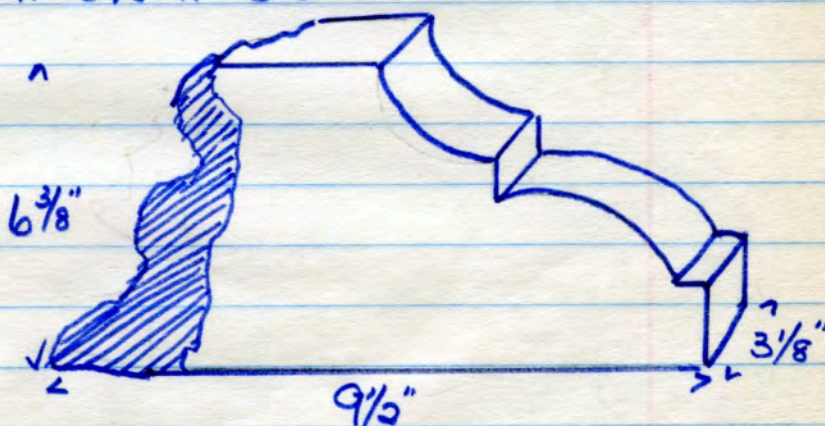

Duckett's dem.
 Blannel St.
 Burnley.
 15. 2. 81.

x 2405

DOUGLAS 8 plain fine brick, glazed.
 8 lbs. 9" x 4 1/2" x 3" - 2 1/2"
 letters incised.

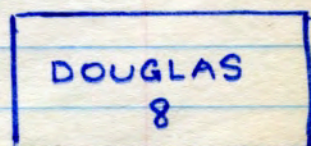

Duckett's dem. Blannel St. Burnley.

15. 2. 81 Douglas Fireclay Wks. Dalry, Ayrshire 1914 - 1960

2410^x

fire brick, closer.
5 lbs $8\frac{3}{4}" \times 2\frac{3}{16}" \times 2\frac{3}{16}"$

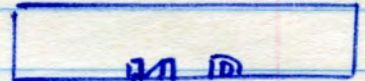

2415
x

found along with full size bricks
marked N B.

Duckett's dem. Blannell St Burnley. 25. 2. 81

No name. salt glazed.

Oblong dish top with anti-splash sides, with
square grate (hinged) to circular outlet below.

40 lbs. $\frac{3}{8}"$ chamfer round all sides of base.

$18" \times 11" \times 4"$ grate $5\frac{3}{4}" \times 5\frac{3}{4}"$

projection of outlet $1\frac{1}{4}"$

2423
x

Nelson Gas Works. 29. 3. 49.

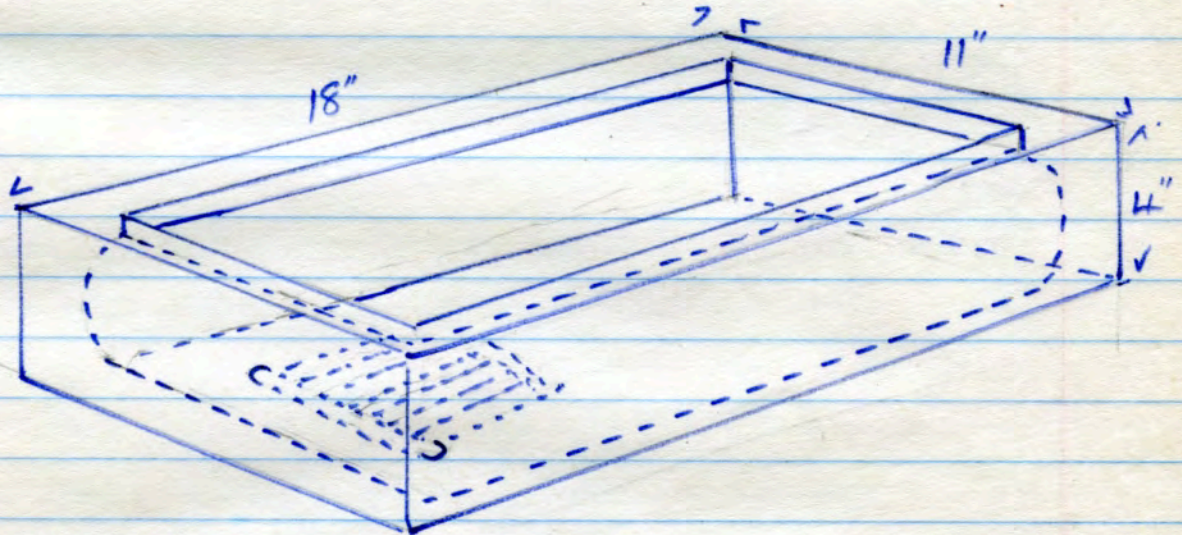

Section through grate

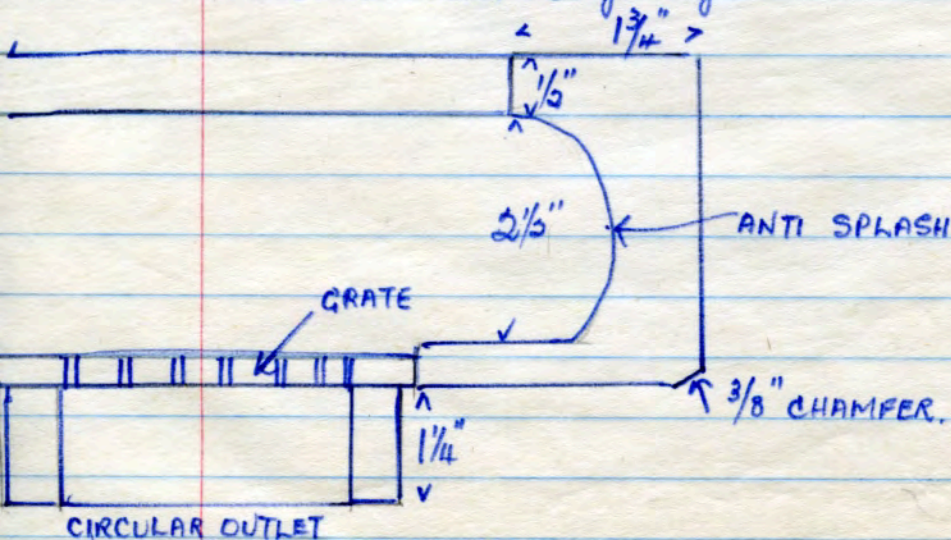

No name. fine clay drain pipe

21 lbs.

19" x 5" x 5"

circular hole through length of pipe 2 3/4" diam.

5 holes 1" diam in each side.

Ducketts dem. Blannell St. Burnley. 26. 2. 81

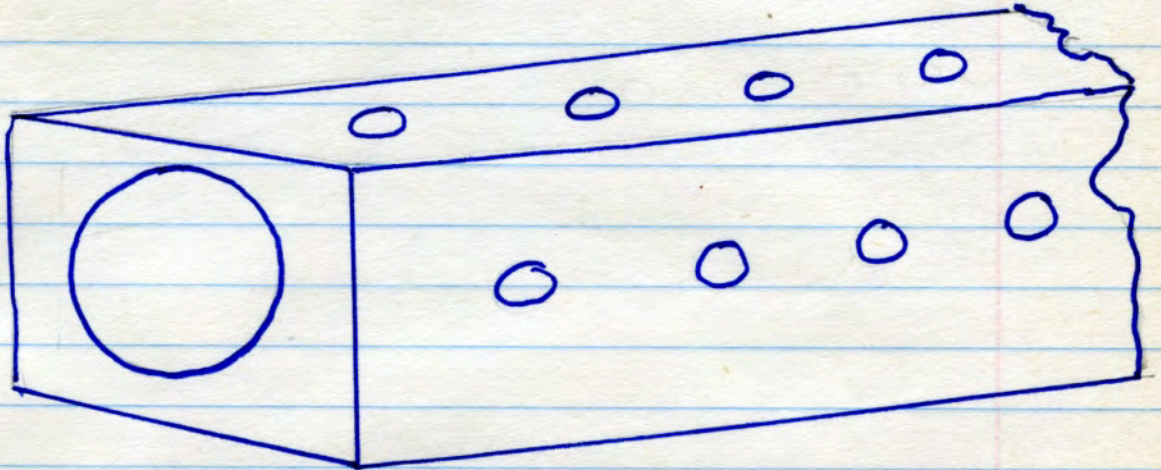

BROOK & PICKUP. TOWNELEY COLLIERY, BURNLEY

11 lbs (complete) 12" x 12" x 2 1/4" (when complete)

part fine clay floor tile, salt glazed.

6 Δ panels 1 \diamond panel on reverse.

Ducketts dem. Blannell St. Burnley 26. 2. 81

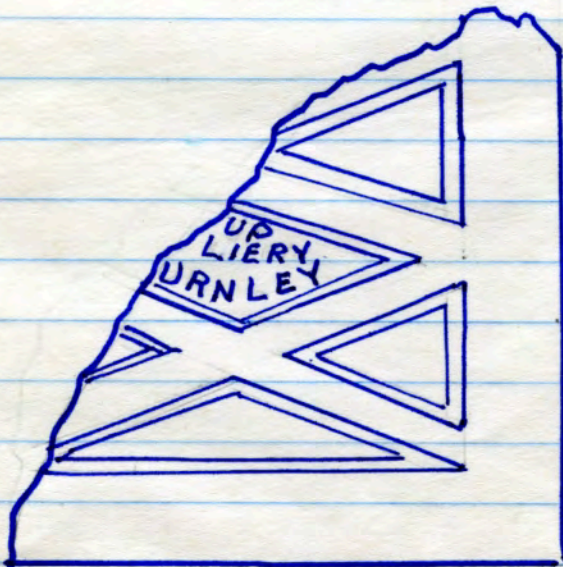

BH 1XL (Bispham Hall, Ornell)
 boiler seating. fine clay
 no panels. stamped on base
 Tip. Foundry Vale 5. 3. 81.
 68 lbs.

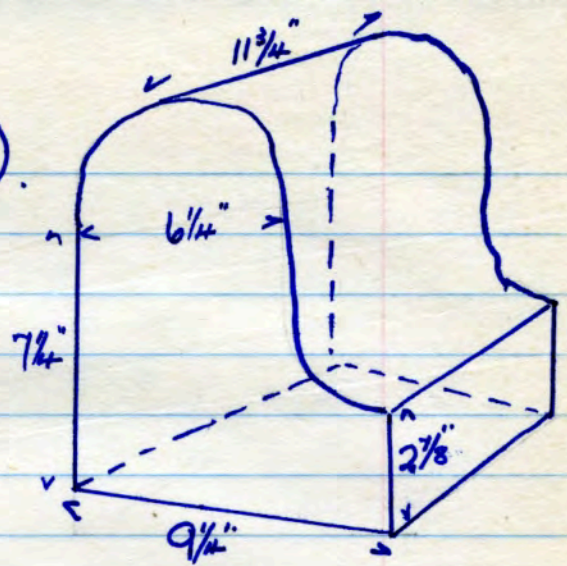

No name. Fine clay drain
 13 holes 2 1/4" diam ext - 1 3/4" diam int.
 2x2 group 3x3 group.
 38 lbs

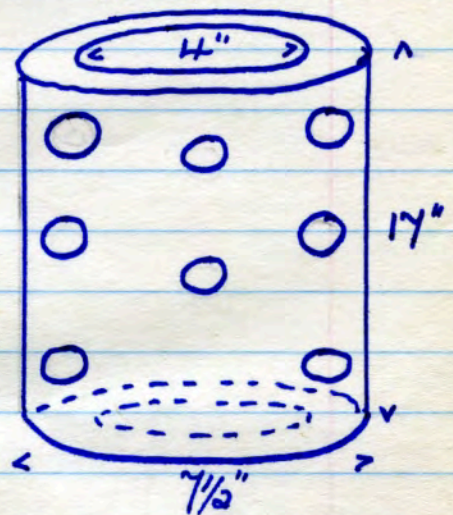

section through
 holes.

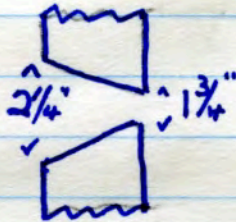

5. 3. 81.

Thos Temperley's. Sharneyford.

DOUGLAS O Douglas fine clay Wks.
 Daisy Ayrshire 1914 - 1960.
 7 lbs. 8 3/4" x 4 3/8" x 2 3/16"

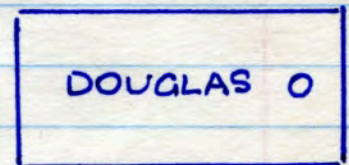

no panels. letters incised
 Tip. Foundry Vale. W/foot. 7. 3. 81

~~ARLEY ICK CO
 7 1/2 lbs 8 7/8" x 4 1/4" x 3"
 single panel each side~~

No name. gauged 2 ways
 33 lbs 13 3/4" x 4 3/4" - 4" x 4 7/8" - 4 1/4"

Leptak Bradley Ltd Industrial
 Furnace Enclosures. 19. 10. 80.
 Broughton Lane, Lower Broughton M/r.

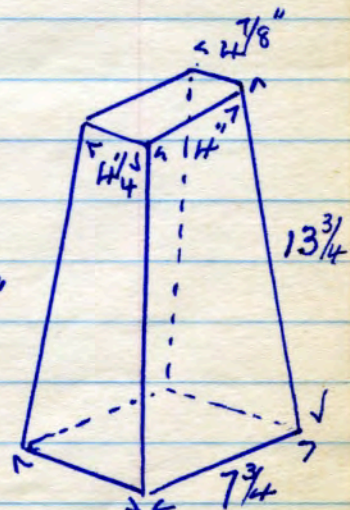

2447
x ✓

1 CINDRILS quaged in thickness 1 in width.
6 lbs. $8\frac{7}{8}" \times 3\frac{3}{4}" - 3\frac{3}{8}" \times 2\frac{7}{8}" - 2\frac{3}{8}"$
letters stamped in very narrow panel
Temperley's, Saunders blough, clearance
site. 2. H. 81.

1 CINDRILS

2539
x ✓

MOSSITE. 1 fine brick. yellow
10 lbs. $9" \times 4\frac{1}{2}" \times 3"$
letters incised
Quest St. house dem. Leigh. 19. 5. 81

MOSSITE. 1

2541
x ✓

ADAMENT yellow fine brick.
10 lbs. $9" \times 4\frac{1}{2}" \times 2\frac{7}{8}"$
letters incised obs. ridged rev.
Spare land off Messer St. Warrington 24. 5. 81.

ADAMENT

2542
x ✓

E BOWEN STOURBRIDGE fine brick.
7 lbs. $9" \times 4\frac{3}{8}" \times 2\frac{1}{2}"$
letters stamped obs. plain rev.
Spare land off Messer St. Warrington. 24. 5. 81

E BOWEN
STOURBRIDGE

2594
x ✓

Glenboig Star Fireclay Wks, Glenboig, Lanark. 1836-1950.
GLENBOIG A1 A yellow fine brick
9 lbs. $8\frac{3}{4}" \times 4\frac{3}{8}" \times 2\frac{7}{8}"$
letters stamped obs. plain rev.
Belle Green tip, Wigan. 21. 6. 81

GLENBOIG A1
A

2599
x ✓

F B fine
8 lbs. $8\frac{7}{8}" \times 4\frac{1}{4}" \times 3"$
letters stamped (small) on 1 end.
Belle Green tip. Wigan 31. 6. 81

FB

2601
x ✓

GLENBOIG A1 as 2594 above
8 1/2 lbs. $8\frac{7}{8}" \times 4\frac{1}{2}" \times 3"$
letters stamped obs. plain rev.
Belle Green tip. Wigan. 21. 6. 81

GLENBOIG A1

PERRENS & HARRISON STOURBRIDGE

7 lbs. 9" x 4 1/2" x 2 1/2"

2602

letters stamped obv. plain rev.
Belle Green tip, Wigan. 21. 6. 81

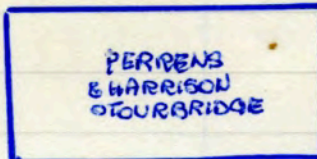

ATLAS plain fire brick.

9 1/2 lbs. 9 1/16" x 4 3/8" x 3"

2603

letters stamped obv. plain rev.
Belle Green tip, Wigan. 21. 6. 81



DYKEHEAD 7 tapered fire brick.

7 lbs. 8 3/4" x 3 7/8" - 3 1/4" x 3"

2604

name & no. stamped obv.
Belle Green tip, Wigan. 21. 6. 81



PR 37 3 - 2 1/2 quaged

2605

7 1/2 lbs. 8 7/8" x 4 3/8" x 3" - 2 1/2"

stamped obv. plain rev.

James Pickup, Fire clay & ceramics, Mason St.
Howich. 21. 6. 81

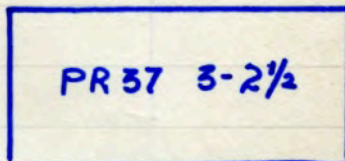

Glenboig Star Fireclay Wks, Glenboig, Lanark 1836 - 1950.

GLENSOIG Y12 tapered fire brick

8 lbs. 9" x 4 7/16" x 3" - 2 1/16"

2644

no panels. name stamped.
Haworth - Worth Valley Rly siding. 9. 8. 81.

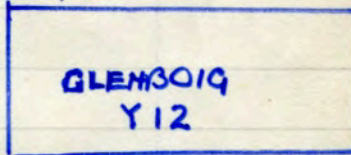

C quaged

7 1/2 lbs. 8 3/4" x 4 5/16" x 2 7/8" - 1 7/8"

no panels. letter stamped.

2660

Duckett's dem. Blannel St Burnley.
25. 8. 81

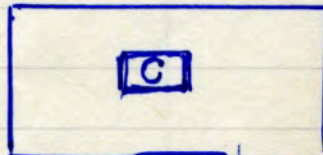

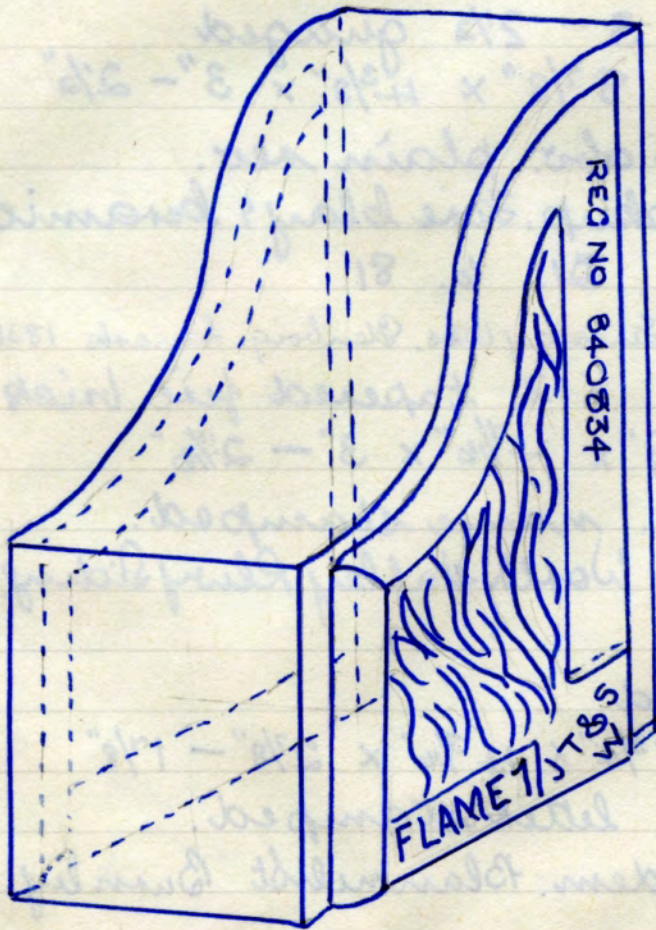

No name.

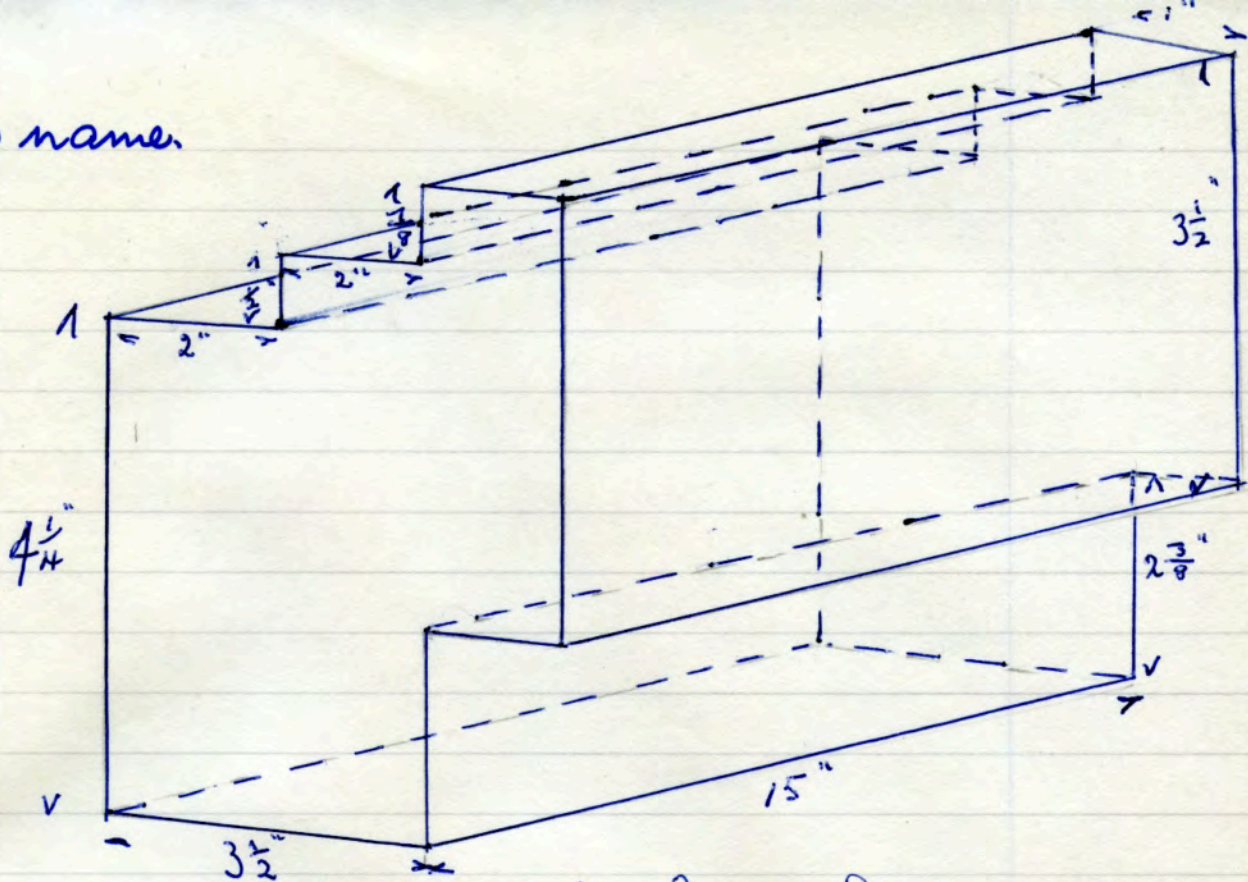

2662
x

Weight 23 lbs

fine clay block for fire place (lintel)

Daisyfield dem. Blackburn. 27. 9. 81.

BRANDON plain fire brick

9 lbs $8\frac{7}{8}'' \times 4\frac{1}{2}'' \times 2\frac{13}{16}''$

BRANDON.

2684
x

name stamped 1 side only
no panels.

Tip at Shack. 5. 11. 81. (R. Ashworth's - Langholme)

FLAME 1 JT&S 'W REG NO 840834 obs.

" " TENNAWARE rev.

1149

buff, fire side bricks 4 lbs. $6\frac{3}{4}'' - 4'' \times 5\frac{3}{4}'' \times 1\frac{1}{2}''$
Palmerston St tip Ancoats 21. 2. 82.

STAR WORKS GLENBOIG tapered XX

8 lbs. $9'' \times 4\frac{1}{4}'' - 3\frac{1}{4}'' \times 3''$

X STAR WORKS
X GLENBOIG

2737

no panels. letters incised faint

Palmerston St tip, Ancoats 21. 2. 82

Glenboig Star Fireclay Wks. Glenboig, Lanark 1836-1950

3309 1 piece of sanitary pipe bearing stamp of the firm which took over the Towneley colliery concern - East Lancs Fire clay Ltd. (branch of Hepworth closed 1982. E L D F Found at Handgate, Shawforth which had been taken over by Hepworths and used as a tip.

BROOKS & PICKUP TOWNELEY COLLIERY BURNLEY.

7 lbs. $9\frac{1}{8}'' \times 4\frac{3}{8}'' \times 2\frac{9}{8}''$ cream.
no panels.

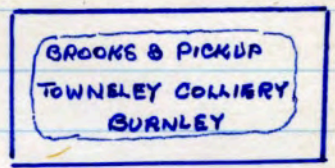

2927 letters stamped 1 side only.
Towneley colliery dem. 28. 7. 82

P B
5 lbs $8\frac{7}{8}'' \times 4\frac{1}{4}'' \times 1\frac{7}{8}''$

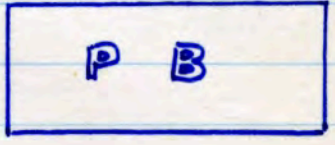

2928 no panels
letters incised (splash marks burnt in).
Towneley colliery dem. 28. 7. 82.

B · P tapered
5 lbs. $8\frac{1}{4}'' \times 3\frac{7}{8}'' - 3\frac{3}{8}'' \times 2\frac{1}{2}''$

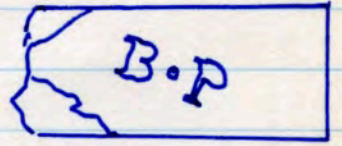

2929 no panels. shows burnings from kiln
letters incised
Towneley colliery dem. 28. 7. 82.

2930 no name. purpose made flue brick
6 lbs. $8\frac{7}{8}'' \times 4\frac{1}{2}'' \times 2\frac{5}{8}''$
no panels. cream.
Towneley colliery dem. 28. 7. 82.

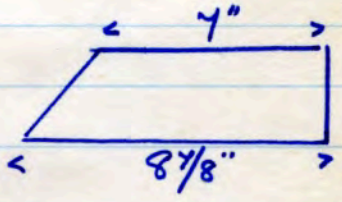

2931 B purpose made partition brick. T.C.
 $3\frac{1}{2}$ lbs. $9\frac{1}{4}'' \times 5'' \times 2\frac{1}{2}''$ cream.
2 panels $3\frac{3}{8}'' \times 2\frac{3}{4}'' \times 1\frac{3}{4}''$
letter incised on base of 1 panel.
Towneley colliery dem. 28. 7. 82.

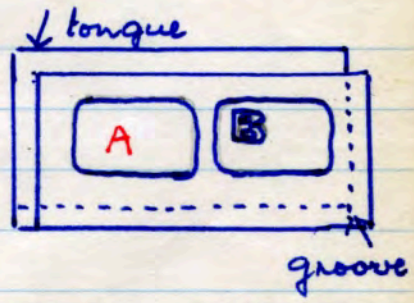

3308 spec. as 2931. letter A in 1st panel, instead of B. Landgate, Shawforth
no name. circular boss, chamfered & beaded

2932 $1\frac{1}{2}$ lbs. 6" diam. x 2" deep. putty colour.
 $3\frac{1}{4}''$ diam. hole insert. 1" deep.
centre hole $1\frac{5}{16}''$ diam. $1\frac{5}{16}''$ deep.
Towneley colliery dem. 28. 7. 82.

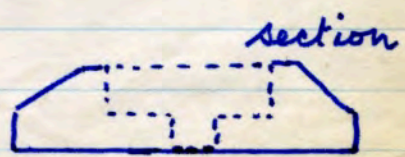

NETTLE D. plain fine brk. tapered

9 lbs. 9" x 4 3/8" x 3" - 2 3/4"

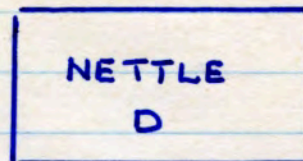

2950

no panels, letters incised

Lip-Snowden & Bridge. 8. 9. 82.

W plain fine brk.

8 1/2 lbs. 8 7/8" x 4 1/2" x 2 7/8"

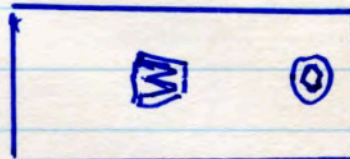

2974

letter incised.

Alder Mill dem. Leigh 14. 10. 82

C C plain fine brk.

8 lbs. 8 7/8" x 4 3/8" x 2 3/4"

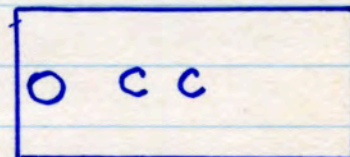

letters incised

2975

Swan Lane Mill, chimney dem. Bolton. 14. 10. 82.

W F plain fire brick

2 @ imprints (pressure points) rev.

10 lbs. 9" x 4 1/2" x 3 1/6"

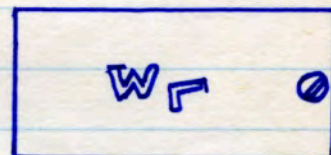

3014

no panels. letters incised obv.

S. Spencer, wall dem. brewe. 15. 4. 83

L B 8 kiln brick.

11 1/2 lbs 12" x 4 1/2" x 3 1/8"

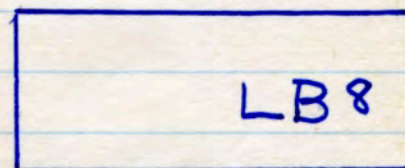

3120

no panels. letters incised obv.

1 cavity in rev. 4" x 3/4"

Shaw's. Darwen. 2. 6. 83.

S HAW S obv DA RW EN rev. gauged

7 lbs. 8 7/8" x 4 3/8" x 2 5/16" - 2 1/4"

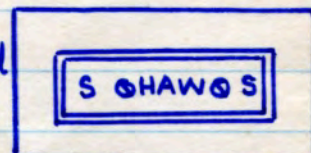

3188

single panel each side

letters in relief

kiln dem. Shaw's. Darwen. 22. 7. 83



could be a fine clay brick prepared for glazing.

1884-

3189 Φ (James Dougall, Bonnybridge, Stirling) cinnamon.
 3 lbs $9\frac{1}{8}" \times 4\frac{5}{8}" \times 3"$
 no panels. letters incised.
 special brick made for kiln lining.
 Kiln dem. Shaws. Darwen. 22. 7. 83.

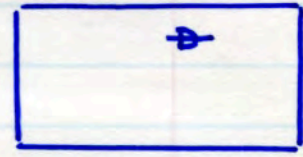

3212 TOWNELEY COLLIERY
 8 1/2 lbs. $9" \times 4\frac{1}{2}" \times 3\frac{1}{8}"$
 single panel each side. letters incised
 obv. only.
 Gaghills Mill dem. W/foot 13. 8. 83.



3214 RAKE FIREBRICK CO LITTLEBOROUGH
 9 lbs. $9" \times 4\frac{3}{8}" \times 2\frac{7}{8}"$
 single panel obv. only. plain rev.
 letters incised
 Peel St, dem next to Bon. Club. R/boro 1. 9. 83.

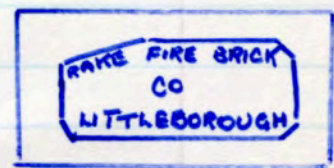

3244 DOUGLAS - X quaged
 8 lbs. $8\frac{7}{8}" \times 4\frac{3}{8}" \times 3" - 2\frac{5}{8}"$
 no panels, letters stamped. double.
 Atherstone Stone & Iron, dem contractors
 for N.C.B. 18. 11. 83.

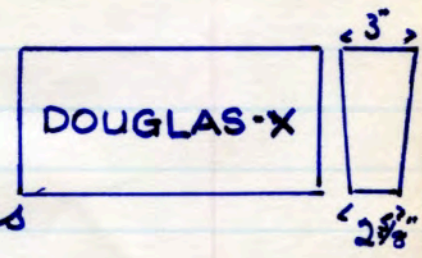

3248 SNEYD COLLIERY BB. quaged tapered.
 7 lbs. $9" \times 4\frac{1}{4}" \otimes 3\frac{5}{8}" \times 3\frac{1}{8}"$
 no panel. letters stamped.
 A S + I 18. 11. 83.

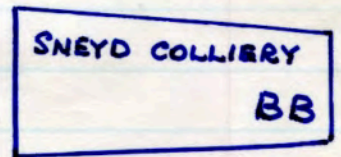

3249 SNEYD COLLIERY BURSLEM N2 BB cambered.
 7 lbs. $8\frac{3}{16}" - 8\frac{1}{4}" \times 4\frac{5}{16}" \times 2\frac{3}{16}"$
 no panels. letters stamped.
 A. S + I 18. 11. 83.

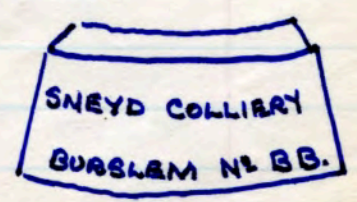

RAMSAY

6³/₄ lbs. 9¹/₈" x 4⁵/₈" x 2¹/₈"

RAMSAY

3261

no panels, letters incised.

Mr R. Able, Plumstead, Norwich 24. 11. 83.

(May have been made by George Heppel Ramsay, Denwortham & Quayside, Newcastle 1848)

FURN - AXE

10 lbs. 9" x 4¹/₂" x 3"

FURN - AXE

3282

no panels, letters incised obv. only.

found at
Wilkinson's Blackley. 8. 4. 84
manufactured by Burn's & Tinsley Co Ltd, Newcastle on Tyne.
works - Stalwood, Morpeth.

GLENBOIG R Glenboig Star Tinsley Wks. 1836 - 1950
Glenboig, Lanark.

9 lbs. 8³/₁₆" x 4¹/₂" x 2¹/₈"

GLENBOIG

R

single narrow panel 5¹/₈" x 3¹/₄" x 1¹/₈" obv. only.

3283.

letters incised.

House repairs. Burnley Rd, Reedsholme, 12. 4. 84

BELLING PATENTED. buff.

7 lbs. 6³/₄" x 6³/₄" x 2⁹/₁₆"

collar over all 3³/₄", inside core 2" diam.

collar obv. recessed rev.

letters incised obv. only.

Railway disused, near Masco bldg. 8. 4. 84.



LADLE QUALITY

9 lbs.

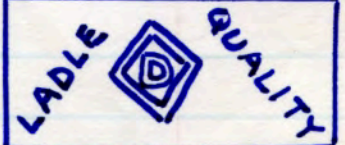

3310

no panels. letters stamped 1 side
plain rev.

Brooks & Brooks Office dem. Bloughfold. 25. 7. 84.

K 867 L furnace partition block. buff.

14 lbs.

18 square perfs $\frac{3}{4}$ " x $\frac{3}{4}$ "

3286 Wilkinsons, Blackley. 8. + 84.

RADCLIFFE

8 lbs. $9\frac{1}{4}$ " x $4\frac{3}{8}$ " x $2\frac{1}{8}$ "

single narrow panel $6\frac{1}{2}$ " x 1", plain rev.

3341 letters incised. thumb mark →

from lime kiln at Hindisfane. 5. 10. 84

Presented by Mrs Frank Sunderland, sec. of Radcliffe Historical Soc. Lancs. (along with slide to show site)

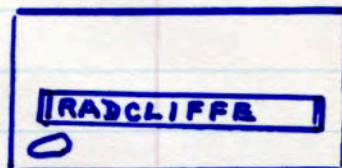

ELX heater brick

3352 14 lbs 9" x $5\frac{1}{4}$ " x $4\frac{1}{4}$ "

no panels. letters incised clear. on end.

Tip at Snowden + Bridge. W/foot. 17. 10. 84



STAR WORKS GLENBOIG  D

3354 8 lbs. 9" x $4\frac{1}{2}$ " x 3"

single shallow pressed panel obv. only

letters incised. obv. only

Old Bakehouse (R. B. Seville) Stansfield Rd. Waterfoot.

17. 110. 84. Glenboig Star Fireclay Works, Glenboig, Lanark. 1836-1950

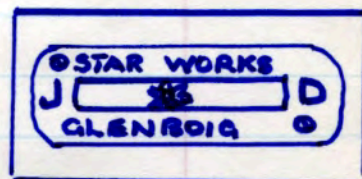

THISTLE

6 lbs $8\frac{13}{16}$ " x $2\frac{7}{8}$ " x $2\frac{7}{8}$ "

3403 no panels. letters incised obv. only

Broadbent's Foundry dem. Ashton-u-Lyne 12. 5. 85

Bonnybridge, Silica + Fireclay Co Ltd, Stirlingshire.

© G T ©

1874-1971.

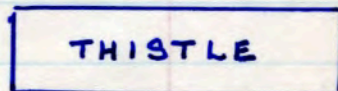

3404 9 lbs. 9" x $4\frac{1}{2}$ " x 3"

no panels. letters incised obv. only

Broadbent's Foundry dem. Ashton-u-Lyne 12. 5. 85

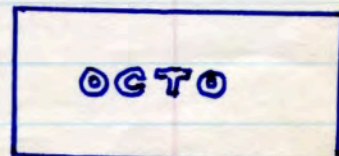

Castlecary Fireclay & Lime Wks. Kilsyth, Stirling.
CASTLECARY 1883 - 1960

9 lbs. $8\frac{1}{8}'' \times 4\frac{3}{8}'' \times 3''$

3405

no panels, letters incised obv. only
Broadbent's Foundry dem. Ashton - u. Lyne
12. 5. 85

CASTLECARY

Bonnybridge Silica & Fireclay Brk Wks. B/b. Stirling
BONNYBRIDGE BRAND 1874 - 1971

3406

10 lbs $9'' \times 4\frac{1}{2}'' \times 3\frac{1}{8}''$

no panels, letters incised obv. only
Broadbent's Foundry dem. Ashton - u. Lyne. 12. 5. 85

BONNYBRIDGE
BRAND

MALTON

9 lbs. $9'' \times 4\frac{1}{2}'' \times 3''$

3407

no panels, letters incised obv. only
Broadbent's Foundry dem. Ashton - u. Lyne 12. 5. 85

MALTON

COWEN • M cream fireclay

9 lbs $8\frac{1}{8}'' \times 4\frac{3}{8}'' \times 3''$

3417

no panels, letters incised
Broadbent's Foundry dem. Bavendish St. A. u. L. 19. 5. 85

COWEN • M

NETTLE D Stein - late 19th

13 lbs. $9'' \times 6'' \times 3''$

3421

no panels, letters incised
~~Broadbent's Foundry dem. Ashton - u. Lyne. 2.~~
Mrs Sheila Ashworth, Northallerton, Cleveland 31. 5. 85

NETTLE D

NETTLE D Stein - late 19th

3422

5 lbs $9\frac{1}{8}'' \times 3'' \times 2\frac{1}{4}''$

no panels, letters incised
Broadbent's Foundry dem. Ashton - u. Lyne. 2. 6. 85

NETTLE D

GLENBOIG W12 ^{Glenboig, Lanark} Glenboig Star Fireclay Wks. 1836-1950.
8 1/2 lbs. 9" x 4 3/8" x 3"

GLENBOIG
W12

3423

no panels. letters incised.

Broadbent's Foundry dem. Ashton-u-Lyne. 2. 6. 85

Atlas Firebrick Wks, Bathgate, West Lothian 1882-1973

ATLAS + A tapered

8 lbs 8 7/8" x 4 3/8" x 2 7/8" - 2 5/8"

ATLAS + A

3424

no panels. letters small, incised

Broadbent's Foundry dem. A-u-L. 2. 6. 85

Lythe Wks, Bolchester, Essex.

MOLER-SOLID

3 lbs. 9 1/8" x 4 1/2" x 2 7/8"

MOLER-SOLID

3425

no panels, name stamped 1 edge.

Broadbent's Foundry dem. A-u-L. 2. 6. 85

WORTLEY

3513

9 lbs 9" x 4 1/2" x 3"

no panels. name stamped 1 side.

Car park, Riggs Garden Lentree 12. 9. 85

WORTLEY

G C R (George Clarke, Rishton)

7 lbs 8 3/4" x 4 1/4" x 2" (closer)

3514

no panels, letters stamped obv.

Hyndburn Rd dem. Acc/ton 12. 10. 85.

OOG C R OO

ASH

6 lbs 9" x 4 1/2" x 2 7/8"

3539

no panels. letters incised, clear

S. Spencer, Lovelough Print Wks, old boiler house dem. 27. 5. 86

ASH

W F B Witton Fire-Brick Co. Witton le West - Darlington.
5 1/2 lbs. 9" x 4 3/8" - 4 1/8" x 2 3/8" - 2"
letters stamped in impression 3 3/4" x 1"

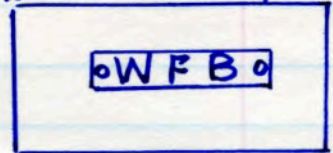

Remains of coke ovens, # Towneley.

Ganister on silica bricks. (Ganister cement)

W F B

7 lbs. 9" x 4 1/2" * 4" x 2 1/2"

letters stamped as above.

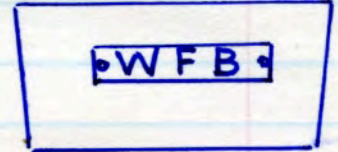

On information from Mr. J. Champness, Conservation Officer a visit was made to Timber Hill, Towneley to see the 12 igloo pattern coke ovens which had belonged to Lelivigen local and Loker Co. The above types of brick were part of the walls of the ovens, from the square to the dome. The bricks in the "common" book, no 3543 were taken from the walls of the oven, below the square.
8. 6. 86.

V

3551

9 lbs. 9" x 4 1/4" x 3"

no panels. letters incised

Lambay Station 20. 7. 86.

United Fireclay Products, Bathville Brk & Fireclay Wks

UNF 56 F

Bathville, West Lothian

1889 - 1960's

3566

8 lbs. 10" x 4 3/4" x 2 5/8"

no panels. letters incised (stamped)

S. Spencer. half key reservoir, #/den Crane

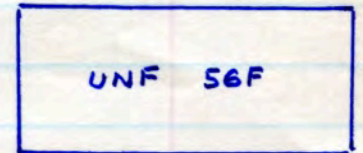

UNF (E) 72213 - 73 F

3568.

16 lbs. 9 3/4" x

no panels. nos & letters stamped.

loan park - blithersoe half key

Haslingden Crane. 29. 9. 86.

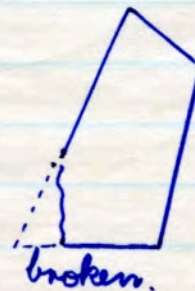

broken.

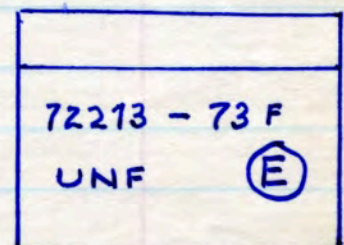

3569 HYSILYN R 1975 - 125 gauged
18 lbs. $11\frac{3}{4}" \otimes 11" \times 4\frac{3}{4}" \times 4"$
no panels. nos & letters stamped.
ban park. blitheroe. 1. 10. '86.

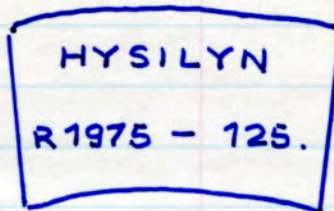

3570 HARD-AXE
7 lbs $8\frac{7}{8}" \times 4\frac{3}{8}" \times 2\frac{9}{16}"$
no panels. letters stamped.
half way. Haslingden Grane. 2. 10. '86.

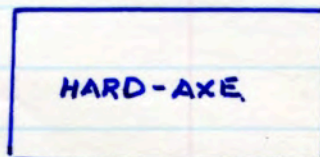

3574 CB (Codin Brothers. Mill Lane ¹⁸⁸¹ Chamber) ^{B/byun}
8 lbs. $8\frac{3}{4}" \times 4\frac{1}{4}" \times 2\frac{1}{2}"$
no panels. letters stamped.
wall dem. St Paul's St. 12. 10. '86

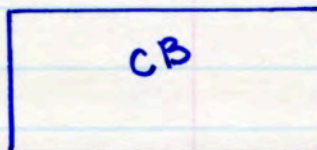

3615 802 ⊠ D
10 1/2 lbs. $17\frac{1}{2}" \times 3\frac{3}{16}" \times 3\frac{3}{16}"$
circular hole $1\frac{5}{8}"$ diam with a
 $\frac{1}{4}"$ thick projecting lip at 1 end only.
opp. end $\frac{1}{4}"$ recess to accept projection.
Mason St. Horwich, Pearlbrook Wks. 6. 9. '84

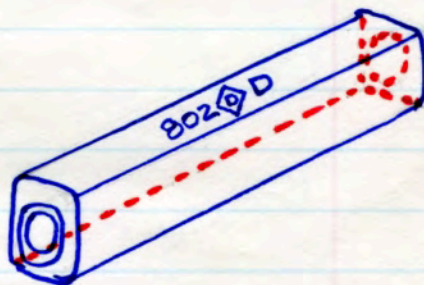

3616 Specification as above but no numbers marked.
7 lbs. $14\frac{1}{4}" \times 3\frac{3}{16}" \times 3\frac{3}{16}"$

3631 BONNYBRIDGE BRAND
9 lbs $9" \times 4\frac{1}{2}" \times 3"$
no panels, letters incised
Mr W. Forrester, Rugby. 26. 10. '87

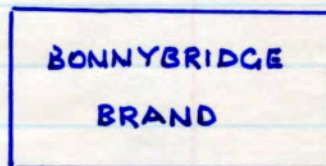

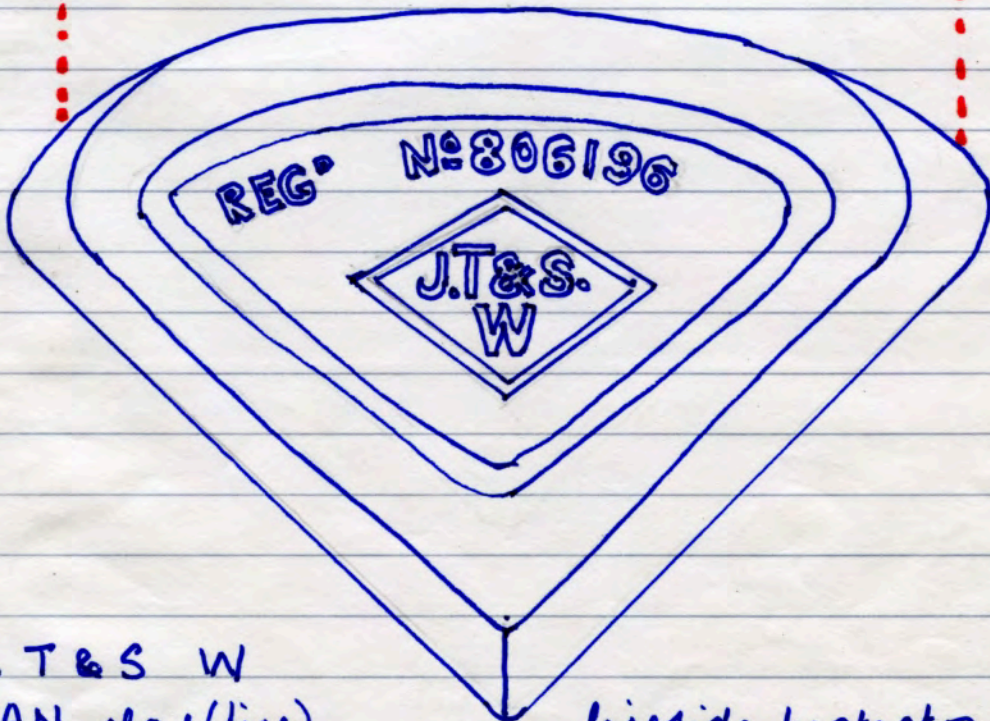
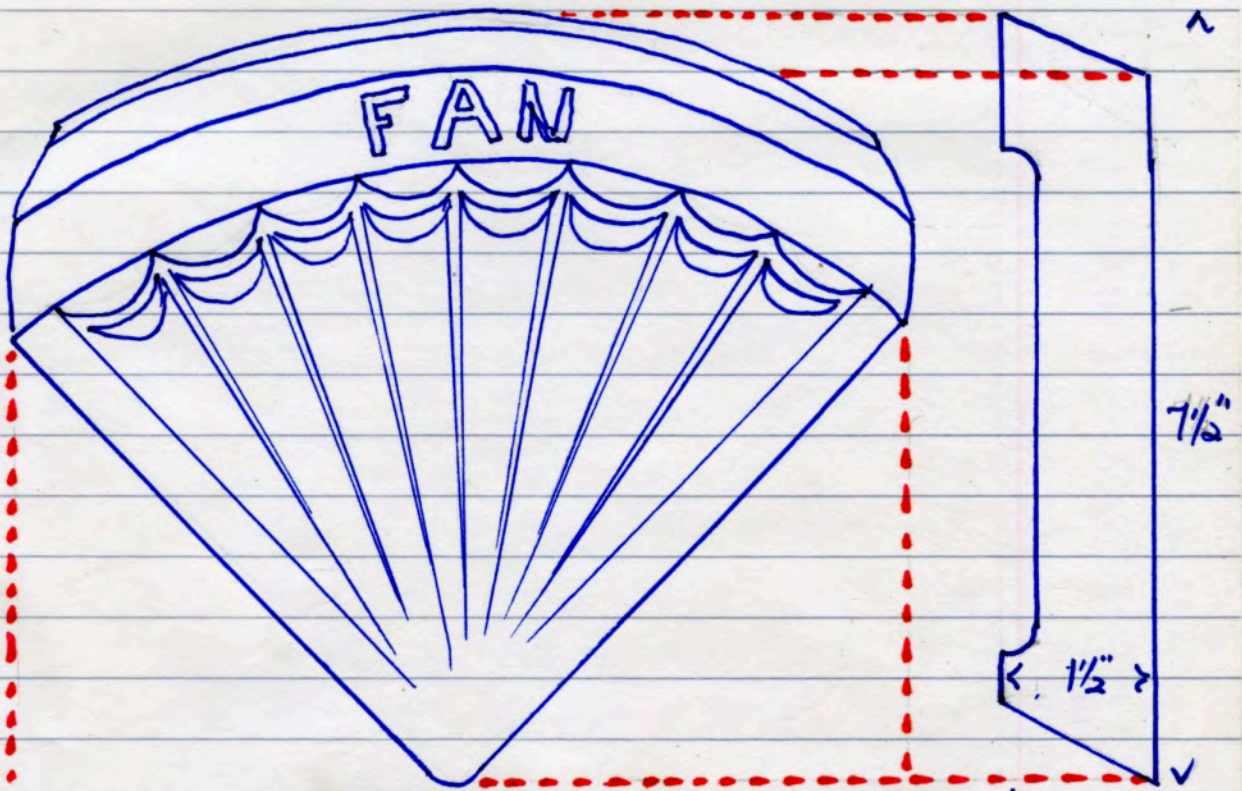

3632

J. T & S W

FAN clay (fine)

blks.

panel with Reg. No in rev.

fireside protector (side)

pattern & fan shape, obv.

letters incised

3633

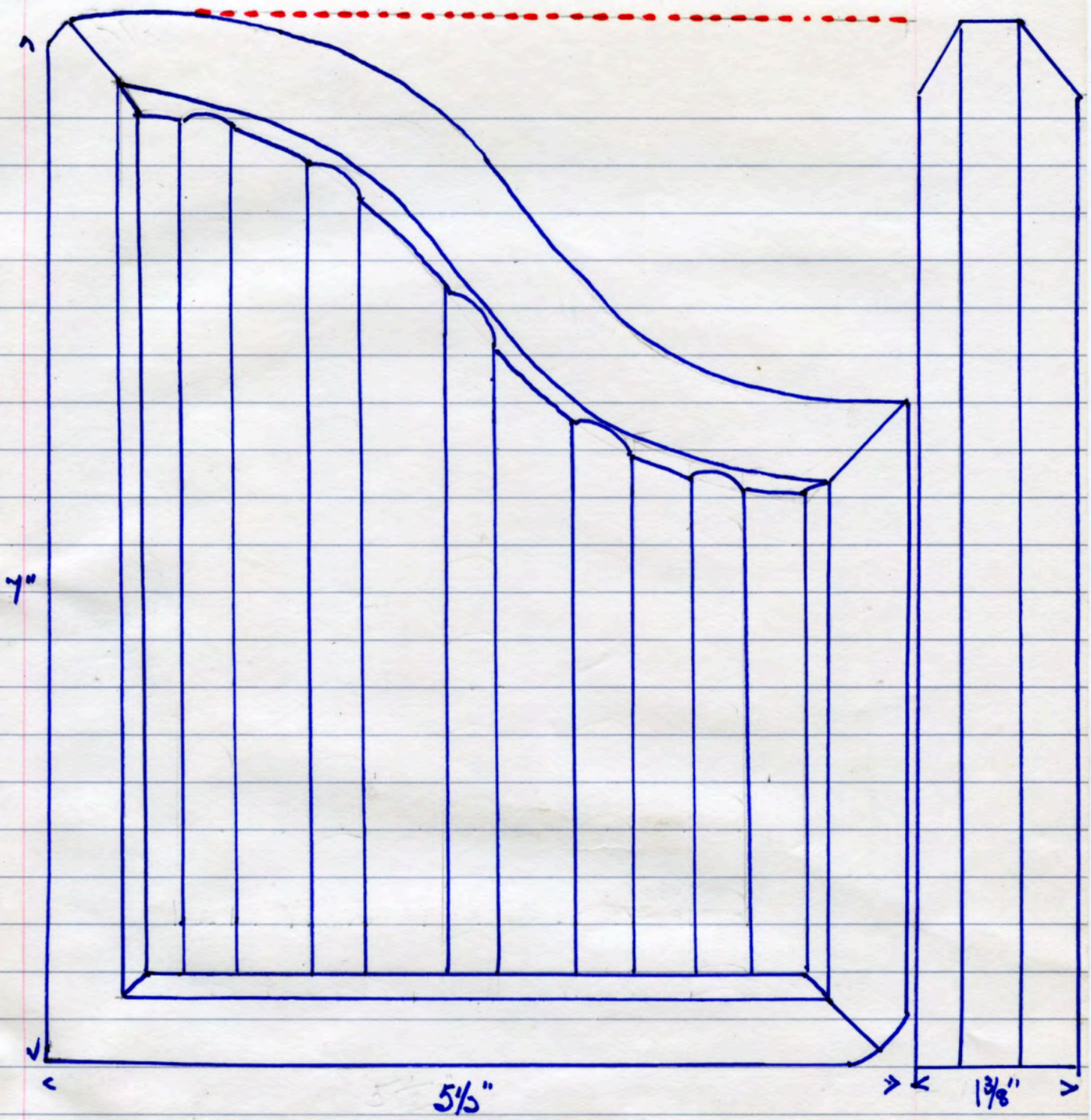

actual size.

No name, fine clay, fireside protector
3 1/2 lbs.
5 ridges in panel each side

3637 2 'DIBDALE' GIBBONS (DUDLEY) LTD. tapered
 9 lbs. $9" \times 4\frac{1}{4}" \times 3" - 2\frac{3}{4}"$
 shallow stamped panel obv. plain rev.
 letters + nos incised obv.
 Hargreaves (originally) R/wy Siding, W/foot
 24. 11. '87

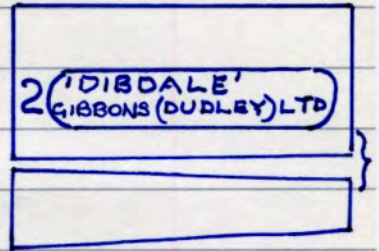

3656 HB
 7 lbs. $8\frac{7}{8}" \times 4\frac{1}{4}" \times 2\frac{3}{8}"$
 no panels, letters stamped obv.
 plain rev.
 Ratchiffe Fold, H/den 3. 3. 88.

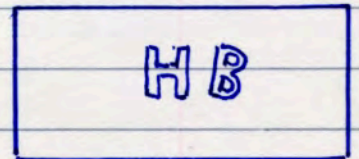

3662 TOWNELEY JOLLIERY BURNLEY
 cream building brick
 7 lbs. $8\frac{3}{4}" \times 4\frac{1}{2}" \times 3\frac{5}{16}"$
 single panel each side, letters in relief.
 dem. J. L. Whittakers, Slip Rd. Haslingden.
 25. 3. 88. note C in reverse J in JOLLIERY.



3663 ADAMANTINE CLINKER. REG^d
 high class stable floor brick
 purpose made. yellow. 2 lbs.
 no panels, letters incised. stamped on base.
 $6\frac{1}{8}" \times 2\frac{5}{8}" \times 1\frac{3}{4}"$
 Reedyford Hospital grounds (Stable dem).

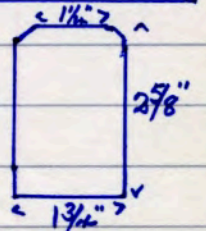
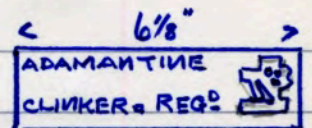

3694 MIDDLETON LEEDS ENGLAND
 7 lbs. $9" \times 4\frac{1}{2}" \times 3"$
 single panel obv. only, plain rev.
 letters incised.
 Higginshaw Lane, Oldham Gasworks dem. 28. 8. '88.



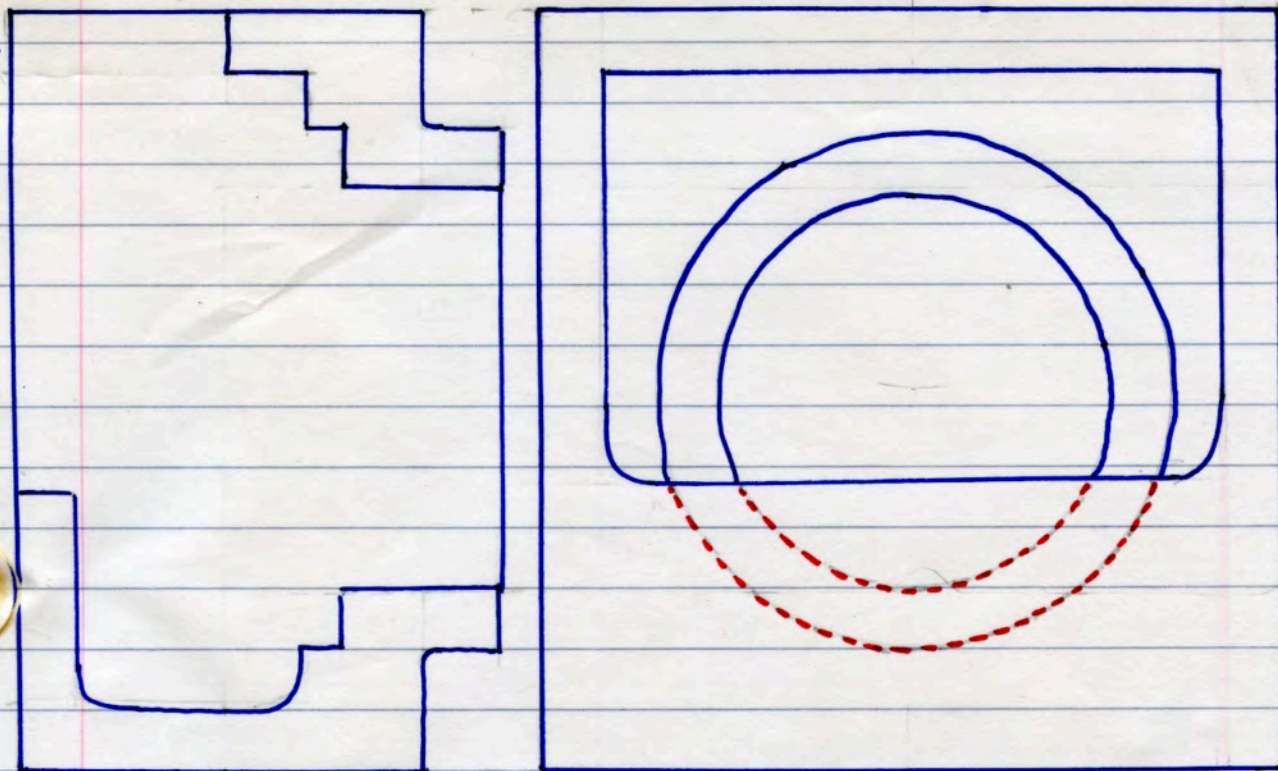

3664 No name (Temperley?). anti-splash gate
 salt glazed fireclay.
 21 lbs. 12" x 10" x 6" 6" diam. exit.
 Ross Trickett's pen. 16. 6. 88.

• G • S E G C (2/3 brick)
 6 1/2 lbs 7" x 4 3/8" x 2 7/8"

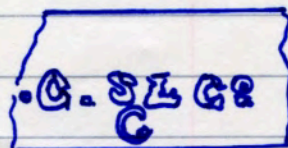

3711 no panels, letters incised, clear.
 Acc/Kon Mori dem. Site 13. 10. '88

HARRIS & PEARSON STOURBRIDGE
 10 lbs. 8 13/16" x 4 3/8" x 2 7/8"

HARRIS & PEARSON
 STOURBRIDGE

3473 no panels, letters incised face edge.
 Acc/Kon Mori dem. site. 25. 10. 88

3774

C  P 70

13 lbs. 9" x 5 7/8" x 2 7/8"

no panels. letters stamped 1 side
Acc/ton Mori dem. site 35. 10. 88.

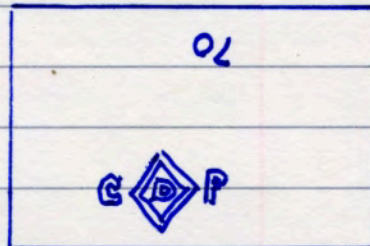

S  R

9 lbs. 9" x 4 1/2" x 3"

single stamped panel obv, plain rev.
Acc/ton Mori. dem. site.

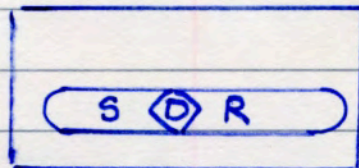

4516

⊖ 3-49-9 S. Spencer, R/stall H. 1. '90
7 lbs. numbers stamped on rev.

4545

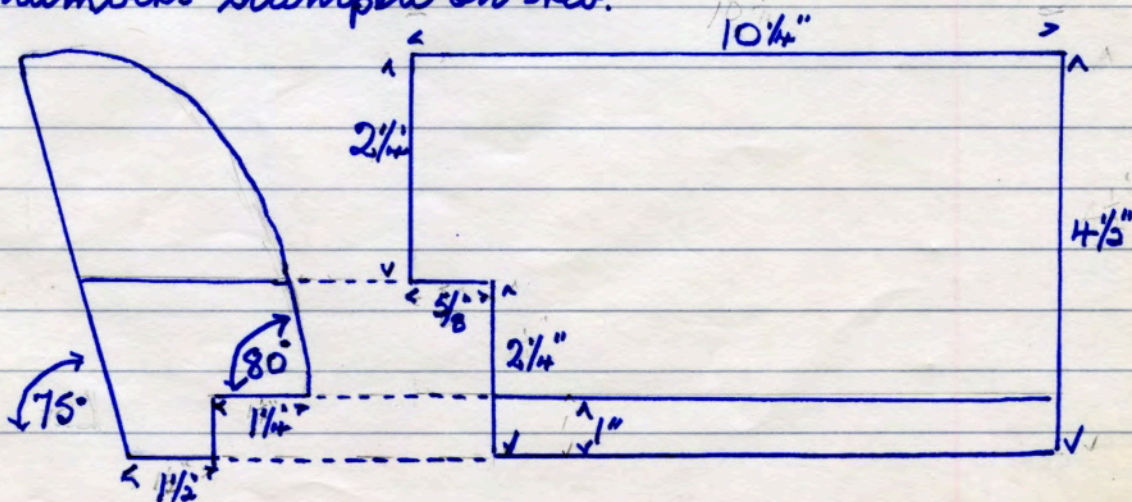

4544.

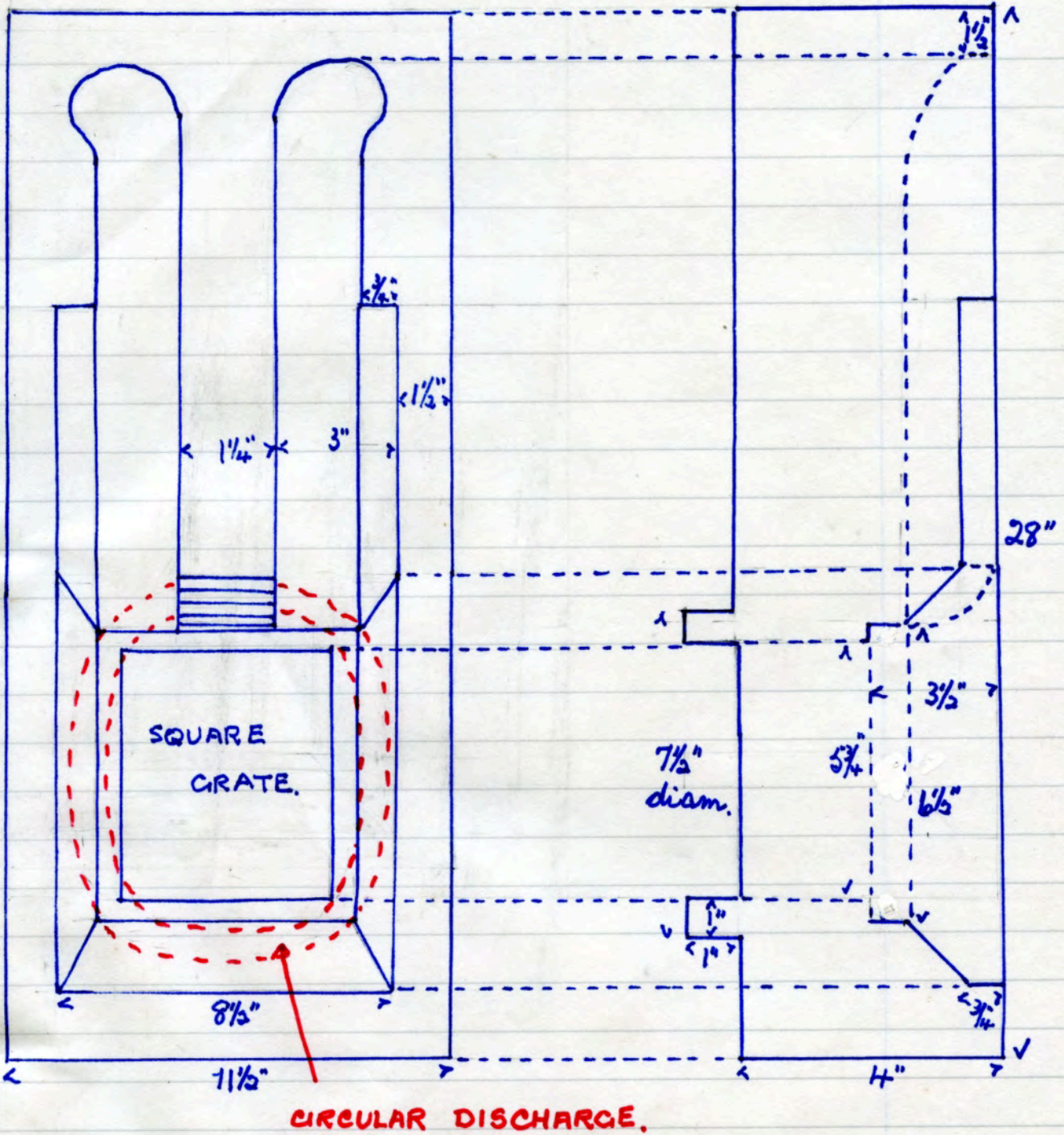

No name. (possibly H. Stephenson, Altham)
fire clay water run and grate. salt glazed finish
70 lbs.
Acclion Mori dem. site 31. 3. '89

4567 J gauged
8 lbs. 9" x 4 1/2" x 3" - 2 5/8"
no panels. letter incised 1 side
Acc/ton Mori dem. site.

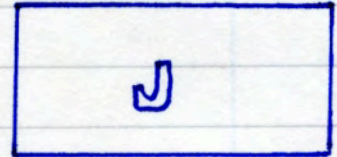

4576 E J & J PEARSON LTD STOURBRIDGE
8 lbs. 8 7/8" x 4 3/8" x 2 15/16"
no panels. letters stamped 1 edge
dem. Bark St. Bolton. 27. 5. '90



5087 HALL OB STOURBRIDGE
7 lbs. 9" x 4 1/2" x 2 1/2"
no panels. letters incised 1 side
dem. Seville's Bakehouse. 8. 9. '91

